

HERO

HERITAGE ECOLOGICAL RESTORATION
FOR INCLUSION OPPORTUNITIES



Co-funded by
the European Union



Inclusive & ecological
heritage restoration training
— Toolkit for professionals & organisations

— TABLE OF CONTENTS

THE PROJECT	03
INTRODUCTION	05
— Cultural heritage at the heart of EU policies for sustainability	06
— Heritage restoration as a lever for vulnerable people training	08
— Traditional building techniques and the environmental transition of the building sector	10
— Methodology	11
SECTION 1 : Pedagogical & technical framework	12
— Pedagogical framework	13
— Technical framework	20
SECTION 2 : Obstacles during training	30
— Peripheral barriers during training	31
— Cognitive skills	34
— Labor law and professional codes	42
— Personal development and empowerment	45
— Heritage-related motivation	47
SECTION 3 : Environmental aspects of heritage building skills	50
— Sustainability & heritage : definition & concepts	51
— Environmental aspects of traditional building techniques & materials	57
— Traditional building techniques for tackling water scarcity	62
CONCLUSION	64
TECHNICAL ANNEXES	65
— Annex 1 - Trainer self assessment grid	65
— Annex 2 - Developing a methodological framework	66
TO GO FURTHER	67
— Pedagogical approach and theoretical foundations	67
ACTIVITY SHEETS	76
— ① Introducing HERO content to trainers	76
— ② Masonry	79
— ③ Paving	82
— ④ Coating	85
— ⑤ Cobbled Stone Paving	87
— ⑥ Masonry repointing	91
— ⑦ Restoring dry stone retaining, single and double stack walls	95
— ⑧ Restoring a stone slate roof	103
— ⑨ Heritage site restoration workshop camp	106
— ⑩ Workshop organization	110
BIBLIOGRAPHY	112

THE PROJECT



An apprentice guided by the craftsman on the construction of drystone pathway, Epirus, Greece.

HERO - Heritage Ecological Restoration for Inclusion Opportunities - aims to improve and enhance the training of trainers in the field of built heritage restoration, while emphasizing the inclusion of vulnerable people as well as promoting and implementing environmentally sustainable practices. The project is the result of a transnational cooperation between ACTA VISTA and BAO FORMATION (France), BOULOUKI - Itinerant Workshop on Traditional Building Techniques (Greece), 4 GRADA DRAGODID (Croatia) and POUR LA SOLIDARITÉ (Belgium). The partners are interested in working at the intersection of heritage restoration, training and employment. The project is funded by the Erasmus+ program for the period from December 2021 to October 2024. The HERO project aims to identify innovative European initiatives in the fields of heritage, adult training and sustainability, to deliver educational material and ultimately to promote new solutions for policymakers.

The project's objective stands at the cross point of social, cultural and environmental policies. In order to approach the issues addressed by HERO in a holistic way, one must be fully aware and take into account decisions and actions developed in these different areas. HERO is fully aligned with the five Pillars of the "*European Framework for Action on Cultural Heritage*"^[1] and their specific clusters of actions to address the following objectives and challenges:

- Unemployment with back-to-work solutions and experimentation (pillars 1 - 2);
- Lack of skilled workers with vocational training in heritage and environmentally oriented trades (pillar 2);
- Preservations of endangered intangible heritage alongside the restoration and management of sites (pillar 3);
- Need for an ecological shift on heritage restoration and modern building sector (pillar 2);
- Lack of resources within our fields addressing the need to capitalize on experiences and produce open operational tools (pillar 4) as well as fostering social cohesion through a multidisciplinary and cross-national European project (pillar 5).

The focus of the HERO project revolves around the concept of "**active inclusion through heritage**".

Through upskilling and reskilling of practitioners, it aims at leveraging the potential of cultural heritage as a tool for social and economic integration, personal development, and empowerment.

The content of this toolbox covers various aspects related to heritage-based training and the development of heritage-related skills. It is designed to support trainers who also work with groups of vulnerable people. These trainers can be professionals from various sectors, including education, social work, architecture, site management, engineering, and other heritage-related sectors. They are provided with resources, methodologies, and practical guidance to integrate heritage-based approaches into their training programs.

[1] [European Commission, Directorate-General for Education, Youth, Sport and Culture, a European framework for action on cultural heritage, Publications Office, 2019](#)

INTRODUCTION



Trainer and apprentices while leveling the cobblestone during restoration works, Cyclades, Greece.

The present toolbox is the result of a long-term cooperation between different organizations developing innovative approach to heritage restoration training. It is validated and pilot-tested on target audiences, trainers and trainees of each partner organization, during specific on-site sessions/or hands-on training. The objectives are:

- 1 Enhancing trainers' pedagogical skills to address specific educational and social needs and increase the motivation on engaging with heritage crafts and skills sector;
- 2 Empowering construction and restoration professionals with background knowledge and technical skills to integrate a stronger ecological dimension in their work, but also to develop more inclusive educational activities as trainers.

Cultural heritage at the heart of EU policies for sustainability

In the European Union (EU), cultural heritage and its sustainable management have become a priority in the field of cultural policy. This commitment is reflected in various EU initiatives and policies.

The European Agenda for Culture² introduced in 2007, underlines the importance of cultural heritage as a priority for European cooperation in culture policy and is considered a strategic resource for a sustainable Europe. The Council Conclusions of May 2014³ further reinforced this perspective by highlighting the need for sustainable management of cultural heritage. Being valuable to society from a cultural, environmental, social, and economic point of view, its sustainable management has become a strategic necessity for the 21st century. Considering the unique, non-replaceable and non-interchangeable value of cultural heritage resources, the Council requested the European Commission to conduct a study on “Risk assessment and prevention for safeguarding cultural heritage from the effects of natural disasters and threats caused by human action”⁴. It falls within the framework of the Work Plan for Culture (2015-2018)⁵, specifically within the priority area of cultural heritage.

The New European Agenda for Culture⁶ adopted in 2018 concurrently with the European Year of Cultural Heritage (2018), highlighted the synergies between culture and education, as well as the reinforced links between culture and other policy domains. It also recommended in its economic dimension, **promoting the skills needed by cultural and creative sectors, including digital, entrepreneurial, traditional and specialized skills.**

The connection between culture and other policy areas is made very clear with the European Green Deal: “Many aspects of the European Green Deal, such as building renovation, circular economy, the ‘farm to fork’ strategy and biodiversity, exhibit clear cultural relevance. (...) cultural heritage offers an immense potential to drive climate action, influence consumption patterns and support the transition towards a healthier, greener and fairer society and economy. **Moreover, cultural heritage can be a catalyst for positive change, as it has the power to connect people to places, encourage a sense of belonging and foster social inclusion**”⁷.

[2] Resolution of the Council of 16 November 2007 on a European Agenda for Culture (2007/C 287/01).

[3] Council conclusions of 21 May 2014 on cultural heritage as a strategic resource for a sustainable Europe (2014/C 183/08).

[4] European Commission, Directorate-General for Education, Youth, Sport and Culture, Maxwell, I., Drdácý, M., Vintzileou, E. et al., *Safeguarding cultural heritage from natural and man-made disasters – A comparative analysis of risk management in the EU*, Publications Office, 2018.

[5] Conclusions of the Council and of the Representatives of the Governments of the Member States, meeting within the Council, on a Work Plan for Culture (2015-2018) (2014/C 463/02).

[6] <https://eur-lex.europa.eu/legal-content/EN/TXT/HTML/?uri=CELEX:52018DC0267>

[7] European Cultural Heritage Green Paper, Executive Summary, March 2021, From the Foreword by Herman Parzinger, Executive President of Europa Nostra, p. 4

Environmental awareness and climate change adaptation and mitigation are fundamental aspects of the EU's approach to cultural heritage. In line with this perspective, the EU introduced the New European Bauhaus initiative⁸. This initiative aims to bring together the worlds of art, culture, science, and technology to foster sustainable and inclusive development. The New European Bauhaus seeks to combine heritage expertise with innovative and sustainable methods to tackle the challenges posed by climate change and environmental sustainability.

The construction and heritage restoration industry can be seen as having a greater role in addressing societal challenges and fostering a fair transition that encompasses both ecological concerns and inclusivity. On one hand, these industries are drastically lacking qualified technical workers making heritage restoration sites valuable as training platforms where technical workers can transition into roles as trainers themselves. On the other hand, by reevaluating their processes, establishing modern practices and revitalizing traditional techniques, this industry can also become more sustainable.

Restoring a thatched hay roof of a mountain shelter
Petrebisća, Učka mountain, Croatia



[8] https://new-european-bauhaus.europa.eu/about/about-initiative_en

Heritage restoration as a lever for vulnerable people training

Heritage is key in promoting social inclusion and giving a sense of pride to the person working on an important site, a historical structure, or an artifact. Heritage should be recognized as a shared asset that contributes to societal well-being and development, while also fostering individuals' self-confidence and educational growth. Pride, particularly, plays a crucial role in the integration and learning process, alongside with the sense of belonging and working within the framework of a common heritage.

Heritage restoration is a field of activity that may be accessible to individuals who are not used to typical or traditional pedagogical approaches, who encounter language difficulties or who are more comfortable and capable of working with their hands and using technical skills. We believe that heritage restoration is perfectly suited for a learning-by-doing pedagogy and pedagogy through physical action.

Historical crafts and heritage restoration skills may assist in the creation of professional and training opportunities, through the training and upskilling of people from various vulnerable social groups. These trainees can be individuals, professionals or early-stage masons and technicians, who might also seek social inclusion or professional and personal development opportunities. They may include unemployed individuals looking to enhance their employability, immigrants aiming to integrate into the local community or young people seeking personal growth and empowerment such as young NEETs (not in education, employment or training). Lastly, students and professionals in the modern and historical construction industries often seek opportunities to increase their hands-on skills in architecture and heritage, and often look for learning and training opportunities.

Workshop trainees during restoration works, Epirus, Greece.



The HERO project is particularly interested in the training of these so-called “vulnerable” groups. A prerequisite towards the aforementioned objective involves understanding the crucial role of trainers, their daily practices, as well as the obstacles and challenges they face. Trainers’ technical and pedagogical skills should be strengthened and enhanced to effectively meet the specific educational and social needs, thereby increase motivation to engage with heritage crafts and skills sector. The emerging necessity to adapt the pedagogy of heritage trainers unfolds in three key directions:

- **Increasing the accessibility of working** in Cultural Heritage preservation for people who encounter economic and social difficulties, thus enhancing inclusiveness.
- **Introducing heritage restoration and historical building techniques to a wider audience** as a catalyst for labor market integration and vocational training (upskilling or reskilling)
- **Fostering hands-on and learning by doing approaches** in our educational formats.

The pedagogical approach presented in this toolbox is directly related to the training context of vulnerable people on heritage restoration work sites. This context leads us to make adapted pedagogical choices and to mobilize practices that will promote the acquisition of technical and behavioral skills for audiences with learning difficulties. The main pedagogical choice is learning-by-doing training as a vector of transmission and learning traditional know-how. This approach is inspired by the ancestral tradition of companionship and relies on training courses that alternate theoretical and technical training on educational platforms with on-the-job training sequences.



*Trainee and trainer inspecting a rubble stone wall for restoration
Marseille, France*

Traditional building techniques and the environmental transition of the building sector

The building sector represents 40% of Europe's energy consumption, with 80% of it stemming from fossil fuels, and 36% of EU greenhouse gas emissions⁹. The EU has committed to achieving carbon neutrality by 2050 through the adoption of the European Green Deal, wherein improving energy efficiency in buildings is pivotal to realizing this ambitious goal. Cultural heritage plays a central role in the Green Deal through the Renovation Wave¹⁰ (whose aim is to increase the rate and quality of renovation works of existing buildings so they emit less carbon dioxide) and the New European Bauhaus (see above).

The HERO project considers that understanding local characteristics is key to both preserving our heritage as well as mitigating and reducing the overall environmental impact of the construction sector.

Gathering data, documenting techniques, training and upskilling are much needed. *"Heritage is a source of knowledge – structures that have survived centuries are the most sustainable, their full lifecycle footprint is minimal. Learning from traditional buildings, materials and skills supports innovation throughout the construction sector."*



Stone carving from a workshop participant, Epirus, Greece.

The toolbox also focuses on the environmental and technical dimensions of architectural heritage restoration and is specifically tailored for trainers on the field. The educational objective is to enhance trainers' skills in technical and environmental aspects, ensuring that the expertise of both engineers and craftspeople is acknowledged, while also integrating social and pedagogical approaches. To ensure widespread adoption by trainers and training organizations, the project partners have chosen to focus on heritage building techniques as a field for ecological restoration and on large technical aspects rather than specific issues that often rely on country-based adaptations, resources and contextual considerations.

[9] [Sustainability and cultural heritage | Culture and Creativity \(europa.eu\)](#)

[10] https://energy.ec.europa.eu/topics/energy-efficiency/energy-efficient-buildings/renovation-wave_en

Methodology

In order to be anchored in the field and the daily reality of the trainers, both handbooks are based on questionnaires from the 3 partner organizations. These are shared with trainers, Boulouki (Greece), Dragodid (Croatia) and BAO Formation (France).

The questionnaire regarding inclusive training, shared with 13 trainers, focused on the inclusion of vulnerable people in professional heritage restoration training and how to deal with this challenge from a trainer's point of view. The answers gathered from the questionnaires allowed the project partners to identify the most common daily obstacles and compile solutions that are/can be implemented by the trainers, i.e. extract valuable best practices to form the foundation of our handbook.

The main challenge encountered while working on this handbook stems from the diversity of existing initiatives in heritage training and restoration across Europe: different economic and financial models, different types of monuments (listed heritage, vernacular heritage), and above all, the diversity of trainees (employees, volunteers, vocational training apprentices, etc.), each requiring tailored approaches from trainers to suit their respective training context.

This toolbox aims to have a positive impact on enhancing the training skills of the different types of trainers, despite the different pedagogical contexts, the scale of activities, the duration and resources available.



Traditional stone extraction by the riverside, Epirus, Greece.

1 Pedagogical & technical framework

SECTION



Drystone pathway and lateral walls made of volcanic stones in Cyclades, Greece.

The restoration of heritage sites offers a unique opportunity to impart both technical and behavioral skills to individuals in precarious situations. The pedagogical approach developed in this toolbox is specifically designed to address the needs of persons less receptive to traditional educational methods. It emphasizes hands-on training and the acquisition of traditional craftsmanship.

This section outlines the **pedagogical and technical frameworks** that underpin this approach, highlighting the importance of trainers with dual competencies, the role of real-world experiences, and the use of mistakes as learning tools.

By prioritizing individualized learning paths and continuous assessment, this framework aims to not only equip trainees with the necessary skills but also to empower them as autonomous learners capable of contributing meaningfully to heritage conservation efforts.





Pedagogical framework

The pedagogical approach presented in this toolbox is linked to the training context of people in precarious situations on heritage restoration sites. This context leads us to make adapted pedagogical choices and to mobilize practices that will promote the acquisition of technical and behavioral skills for audiences with learning difficulties.

The main pedagogical choice is that of training through apprenticeship to transmit traditional know-how. This approach is inspired by the ancestral tradition of companionship and is based on training that alternates theoretical and technical courses on educational platforms with training sequences in the field.

1 Trainers with a double competence

The subtlety of the trainer's profession lies in the fact that they must engage on several levels simultaneously:

-  **Imparting** knowledge and skills
-  **Supporting** trainees throughout their journey
-  **Evaluating** the outcomes of the pedagogical proposal in practice
-  **Regulating and adapting** their proposal

This fourfold role requires the trainer to operate in two dimensions at the same time:

- **In the present moment**, focusing on the “production” aspect (transmission, support),
- **In a “Meta” position**, stepping back, observing, and analyzing what is happening, then adjusting accordingly.

A good technical expert does not necessarily make a good trainer. Training is much more than a simple transfer of knowledge. It first and foremost involves processes, methods, tools, and postures that enable the trainee to better achieve the targeted skills. To ensure learning through action, the trainer must be:

- A **Technical expert**, mastering the knowledge and skills of the trades (masonry, carpentry, metalwork, etc.) that they must transmit to the trainees,
- A **Pedagogue**, capable of constructing and leading an adapted pedagogical proposal.

It is with these two “roles” that the trainers will have to compose and construct their stance, between “the one who knows” and “the one who supports all through the learning process”.

1 Pedagogical & technical framework

In any training approach, it is necessary to **determine the final pedagogical objective**: “at the end of the training/session, trainees will be able to...” This leads to the pedagogical staircase that allows trainees to **progressively achieve** competence through intermediate objectives. It is crucial to ensure that the level of learning aligns effectively with the actions and activities required to achieve this goal.

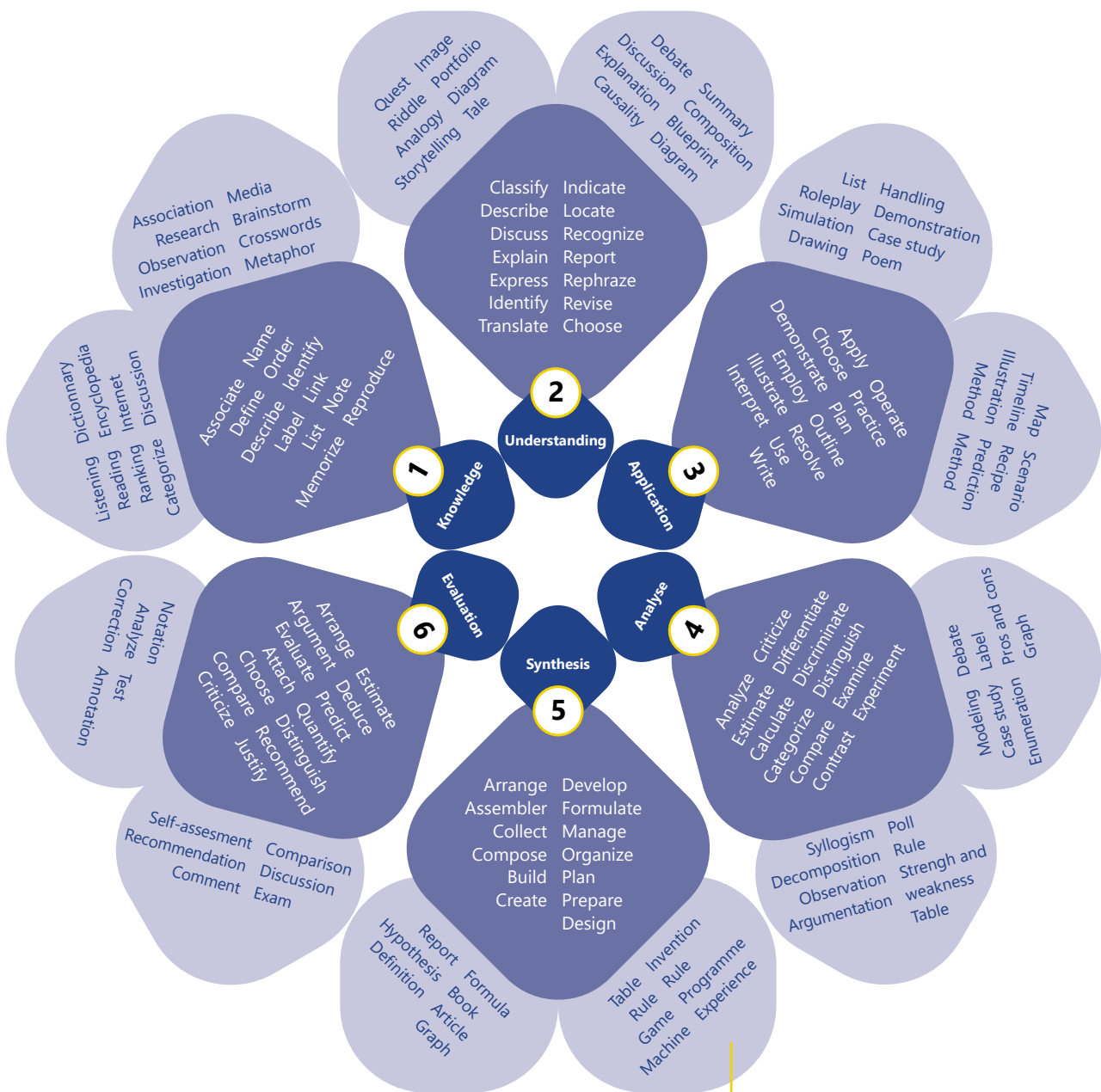

Bloom Taxonomy

2 Prioritize the encounter with reality

Training through action aims to make the trainee capable of performing concrete tasks. To do so, it is first necessary to acquire technical and behavioral skills. Even though theoretical aspects should not be neglected, the **focus of the teaching will indeed be on the "realization" aspect**. For this purpose, it is essential to organize pedagogical sequences during which the trainee will be faced with **real-life situations**. The idea here is to combine two elements: simulations in educational workshops during which the trainee can face real-world situations and real production situations on-site during which the trainee can apply their construction knowledge and transform it into skills.

3 Using error as a pedagogical tool

Since the trainee is the **actor of their learning process**, it's important to enable each one of them to activate their learning processes. One of these processes is learning from mistakes. In this context, the trainer should use the mistake as an opportunity to pinpoint a **skill the trainee has yet to fully grasp** and to provide them with **constructive feedback**. Training through action will facilitate the establishment of pedagogical loops such as:

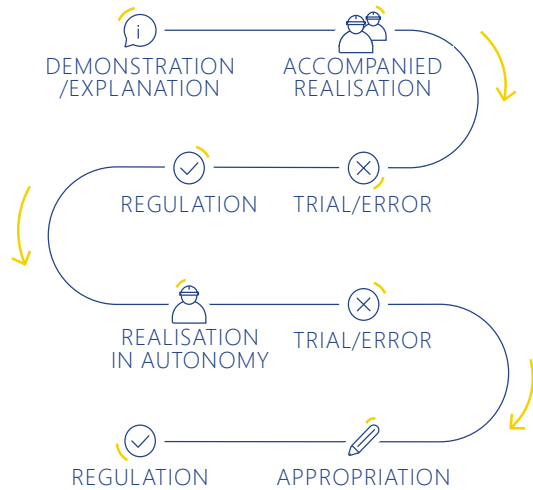

The feedback provided by the trainer will allow the trainee to correct their mistakes and to correctly execute the task assigned to them. Nonetheless, this does not mean that the trainee won't make a mistake next time in a similar situation. The challenge is to determine whether the trainee is merely replicating an action or if, as an autonomous individual, **they have acquired the skills and can mobilize them consciously** in the new situations they encounter.



A stone mason placing the corner stones of a cobblestone, Epirus, Greece.

4 A progressive and individualized approach

We are all different in the way we think, function, learn, and work. Our way of being is the result of a complex combination of elements that refer to our biological and psychological development, as well as our experiences, past experiences, cultural framework, etc.

The trainer must be aware of this in order to **adapt the tools and pedagogy to the progression** of each trainee. Indeed, this will require the trainer to consider the trainee as a complex individual and a subject in their own right, with their own experiences and influences. This will also require adopting a “meta” perspective during their pedagogical sequences, being aware of “what is at play” and retaining the information that will allow them to **refine their actions for greater effectiveness**. Finally, it will also require the trainer to have a wide range of pedagogical tools at their disposal to enable this **adaptation**.

A team of trainees working on the ramparts of the Fort St Nicolas Marseille, France



5 An assessment system as a learning tool

To evaluate the pedagogical progression and the adaptation of the methods, assessment is an indispensable mechanism. Often perceived as a "sanction" whether positive or negative, assessment is primarily a steering tool for the trainer. **Assessment is an integral part of the pedagogical process** and constitutes a learning tool. Generally, it is accepted that there are three major models of pedagogical assessment:

→ Predictive Assessment

This involves measuring the trainee's level before they start the training. It's about making a diagnosis, and checking if the prerequisites for integrating training are met. The trainer will also use it to evaluate the trainee's level and adapt their action to the pedagogical progression.

→ Formative Assessment

This takes place during the training to evaluate what works or doesn't work for the trainees, the degree of skills acquisition in relation to the set objectives, etc.

→ Summative Assessment

This assesses the skills acquired upon completion of the training, to certify that the training objectives have been met.

A fourth category of assessment could be added:

→ Participative Assessment

The trainee, supported by the trainer, assesses their results as well as their actions, and takes a critical look at them. The assessment time then becomes a pedagogical sequence allowing the trainer to guide the trainee in a reflective analysis of their practices and lead them to consolidate their knowledge, identify their mistakes, and take action following their process of reflection and learning.

A trainer explaining technical gestures to a trainee on the ramparts of the Fort St Nicolas Marseille, France



6 Encourage reflective analysis

As previously mentioned the trainer will be able to assess the trainee's progress through various means of assessment or role-playing. These will promote the **identification of errors and their regulation**. But beyond regulation, it will be interesting to **accompany trainees in the analysis of their practices**, to enable them to acquire relevant knowledge.

To do this, it might be beneficial to organize practice analysis sessions during which, thanks to the guidance of the trainer, the trainee can **take a reflective look** at their output.

By prioritizing listening and questioning, the trainer will lead the trainee through a reflective loop that involves the following steps:

“Can you describe the tasks you performed to achieve this result?”
→ Awareness of the actions taken, as well as their verbalization

“What do you think of the result? Is it in line with what was expected?”
→ Trainee's analysis of their realization

“What satisfies you in your work? What do you find particularly successful for you?”
→ Identification and capitalization of good practices

“What satisfies you the least in your work? In your opinion, what could have been done better?”
→ Critical self-reflection

“If the situation occurs again, what would you do to get a better result?”
→ Projection

This process, repeated at different stages of the training, will allow the trainee to **anchor their knowledge** and place them in a process of improving their practices and continuously producing knowledge.



Trainees and trainer manipulating stones on the walls of the Fort Ganteaume
Marseille, France

7 Guidance towards autonomy

Through the implementation of the aforementioned pedagogical mechanisms, the aim is to **make the trainee autonomous** at several levels.

Firstly, the goal is to **make the trainee autonomous throughout their learning journey**. This can be possible for example, by providing pedagogical resources that the trainee will need to consult alone or in a group of trainees. Autonomy can also be stimulated thanks to supervised pedagogical situations during which the trainee can practice, test, and gain confidence.

At the end of the training, the objective can be for the trainee to acquire skills that they can then use to carry out a task or a series of tasks independently.

Another objective can be for the trainee to be able to mobilize their skills, consciously and autonomously, to perform complex tasks and/or tasks not encountered during the training. The trainee will then be capable of **going beyond the reproduction of actions** and creating their own practice in the face of a new situation.

This notion of autonomy no longer places the trainee as a mere "agent" (the one who receives the teaching) but also as an "actor" in the learning process, or even an "author."



Restoring a dry stone wall of a hut, learning by doing
Petrebišća, Učka mountain,
Croatia

It's important to remember that the principles presented here should not be seen as dogmas to which the trainer must imperatively adhere. There's no definitive choice to be made between the different approaches. It's precisely by considering all options, applying them in the context of a given situation, and establishing links between them, that the trainer can **develop a tailored approach and enable personalized learning**.

The trainer who wishes to learn more about the concepts and theories underlying what is proposed here will find a more detailed article in the appendix. The foundational principles of our approach (systemic and complex thinking), the main currents of learning theories (behaviorism, cognitivism, constructivism, socio-constructivism, and connectivism), as well as reflections and tools on various subjects (autonomy, adult education, pedagogical relationship, assessment, pedagogical progression), can be found in the appendix.

Armed with these concepts, the trainer must now create their own pedagogical proposal and "toolbox".

Technical framework

Many European countries are facing labor shortages in the construction industry. Over the next decade, the industry may require an additional 2 million workers. Concurrently, within the European Union, there is a rising number of individuals struggling to access the labor market and training opportunities (for example: migrant populations, early school leavers, people with social and cognitive difficulties, etc.). Offering tailored and inclusive training opportunities is an excellent solution to foster back-to-work programs, with heritage restoration sites acting as dedicated training platforms. This section will provide insights, tips, and best practices to consider when tailoring an inclusive training offer in this specific sector.

1 Developing a training methodology step-by-step

Training is not a predefined path

As mentioned earlier, regardless of the field of intervention, trainers will need to develop and implement a pedagogical proposal and a methodological framework adapted to the training objectives, the context of implementation, and the profiles of the trainees. Moreover, to assess the achievement of the objectives, trainers must be able to **define a set of criteria** that will allow for an objective evaluation of the measurable aspects of their proposal. The trainer will aim to make their sequences inclusive ensuring that all the trainees feel encouraged to engage in the learning process. This preparatory work is essential. However, once the methodological framework has been established, trainers will need to continuously question what is happening to evolve and adapt their pedagogical proposal.



Participants following a craftsperson demonstration on stone processing, Epirus Greece.

● Engaging trainees

In addition to the trainers' ability to analyze and adapt to circumstances, they must also prepare and implement **a process to engage trainees**. This involves an integration phase before the training, during which the trainer focuses on addressing the following five areas:

→ The overall goal of the training

Engaging adults in a pedagogical journey primarily involves allowing them to understand why they are here and what the goal is. Understanding creates meaning, and meaning leads to commitment. The trainer should not overlook this step as it sets a common frame of reference, fostering the emergence of a community with unique individual goals, mobilized around a common objective

→ The training environment

To experience a favorable learning situation, trainees need to develop a feeling of "safety" This entails nurturing a sense of belonging within the group, creating a climate of benevolence, sharing common goals, ensuring physical safety on-site, and familiarizing trainees with the training environment. Therefore, it is advisable to organize a phase where trainees can explore the training location. This will allow them to orient themselves and become familiar with the different spaces (educational platforms, classrooms, social areas, changing rooms, etc.) and their facilities.

→ Safety rules applicable to pedagogical and/or construction activities in heritage restoration

This aspect, which will be detailed later, aims to raise awareness among trainees about the risks associated with the profession, identify them, and implement appropriate preventive actions. It also allows trainees to acquire a concrete idea of the profession and one of its fundamental aspects.

→ **Tools and equipment**

The objective here is for trainees to identify the tools and materials they will be using during their training. This means understanding the different categories of tools and materials, their origins, names, functions, when and how to use them, and what sets them apart. The trainer can rely on technical fact sheets as support. To promote ownership, the trainer can also demonstrate their use and then ask trainees to perform simple tasks as an initial hands-on experience.

→ **Guidelines and basic techniques**

In this step, the trainer will offer sequences that focus on the activities targeted by the training and the completion of specific tasks related to the building/restoration project. The trainer will guide trainees through the steps involved in the task execution process (preparatory work, safety measures, implementation, and quality control) while also ensuring they acquire the right techniques (materials, tools, practices, etc.).

Here are some general tips and best practices collected from field professionals to set up relevant training:

☰ **Creating teams** based on level of experience, gender, origin, age and other factors depending on the involved trainees and the goal of the project (i.e. Get to know your trainees)

👤 **Keeping clear roles** between trainers and trainees

✓ **Rotating teams** in a balanced way between different tasks

✓ **Ensuring enough time** for people practising on their own

✓ **Explaining** how there are no unattractive tasks and rotate all trainees in their conduction

📎 **Giving them regular** personal and teams feedback

📎 **Having daily recaps** on the progress of the works

A set of tools for stone cutting



2 Safety rules

The **safety and well-being** of trainers and trainees are one of the **most important priorities** on the training site. Specific safety rules must be respected by all; if trainers set a good example, it will be easier for trainees to comply. Trainers should encourage the **adoption of safety rules and practices**, for example, by regularly highlighting their correct implementation. Additionally, they can also assign different safety roles and/or responsibilities to the trainees to ensure everyone cooperates.

 General guidelines

- **Do not give too many rules at once.** Start with the most important and simple rules, then, throughout the training, regularly communicate more detailed instructions.
- **Ensure to regularly repeat the rules and provide additional reasoning** in their support when noticing that trainees start forgetting or underestimate a rule during the training.
- **Explain to trainees that they are responsible** for their physical safety and well-being, as well as for the safety equipment provided to them, individually and as a group. Trainees must take care of one another.
- **Inform oneself about safety issues** related to specific tasks that are part of the training (e.g., the use of chemicals or electronics).
- **Plan according to weather conditions** (ensure protection against the sun, rain, etc.). Do not proceed with training if the weather conditions are too harsh: thunderstorms, snowstorms, heat waves...



Safety hats storage shelf



A trainer assisting a trainee to manipulate dangerous tools



Solutions & good practices

- **Provide necessary instructions for the safe use of tools and equipment.** *Dull and improperly secured tools are very dangerous. Therefore, explain to trainees why this aspect is important and how to maintain the sharpness and good condition of tools. Ensure that trainees know which tools they can use at any time and which specific tools require a permit or specific training (power tools).*
- **Propose a group warm-up for physical preparation or delegate it to a trainee.** *Explain to trainees how to safely lift heavy objects by demonstrating. Explain how lifting and handling objects and tools incorrectly leads to poor posture and injuries.*
- **Use impactful safety videos** (such as videos on helmet safety) **or pictograms** to overcome language barriers when describing potential injuries resulting from non-compliance with safety rules.
- **When integrating a trainee, explain and have them sign a "site safety" regulation.** *This makes them accountable.*
- **Consult the Material Safety Data Sheet** for building materials or other types of materials used on the site/workshop.



Checklist before starting training

- Is there enough protective equipment? Is it the right size for everyone (e.g., gloves for women)?
- Are the tools in good condition (sharp, in good condition, not loose, electronics working, etc.)?
- Did I prepare safety instructions/equipment based on the tasks planned for today?
- Did I inquire about the profile and experience of today's trainees? Is it their first time on a construction site? Which languages do they speak?
- Is there one or more specialized or risky tasks to explain?
- Did I prepare the safety declarations/contracts?
- Did I check the weather conditions and prepare accordingly (too hot, too cold, wind conditions, rain, etc.), or if there's too much wind or rain?

3 Worksite organization

The organization of the construction site is a complex topic, but in this context, it can be simplified to a basic theme: the **optimal organization of people, tasks, materials, and tools**. To ensure such an arrangement is possible, choosing the right worksite is also crucial, meaning one that fits the training objectives. This presents us with a set of challenges:

- Selecting the suitable workspace.
- Distributing trainees and trainers across the site in a way that makes the training process safe and efficient.
- Distributing tools and materials so they are available when needed. Tools and materials must not be wasted or lost or slow down work.



A set of tools for stone cutting

General guidelines

The primary goal of the site organization is to **enable trainees to acquire skills rather than aiming to construct a building**. However, these two goals are not mutually exclusive, which requires **planning and coordination**.

When choosing the site, various variables must be considered: the environment, resources, trainees, safety, and most importantly, the type and duration of the training. The requirements are different depending on whether it's for a two-day workshop, a six-month apprenticeship, or a series of shorter modules.

The most important thing is that the layout and size of the site correspond to the expected number and type of trainees.

Everywhere except for the smallest workshops, trainees need to be organized into work teams, whose size and composition are adapted to the trainers, the tasks, and the available resources.

- **Tasks, trainers, as well as the number and size of teams, must be planned.** However, one must be ready to adapt (e.g., changing tasks or teams) in case of unpredictable circumstances.
- **Every day before starting work,** it is necessary to explain to trainees the layout, tasks, use of tools and materials, as well as the safety rules and procedures.
- **Materials and tools must remain accessible but also protected** from damage or waste.
- **Materials and tools should be organized** to be accessible at all times.
- **Special consideration should be given to the storage of tools:** they tend to get lost, damaged, or degrade without proper maintenance.

The site must be maintained throughout the work day to keep it safe and ensure that construction waste, tools, and materials do not get in the way. At the end of the day, finished parts should be cleaned, unfinished ones secured, and materials and tools protected.



Best practices

- **Choose the site keeping in mind the following aspects:**
 - **Trainees:** their abilities, physical condition, age, and the training they need to complete.
 - **Environmental conditions:** expected weather, typical climate for the time of the year, accessibility, safety.
 - **Available resources** (or the possibility of procuring them on site): weather, materials, tools, mechanization, scaffolding, safety equipment, energy, food, water, etc.
- **To properly and correctly distribute trainees on the site, trainers must have an overview of possible or necessary tasks:**
 - **Construction tasks:** what are the construction goals?
 - **Material preparation tasks:** what materials and/or construction elements need to be extracted, prepared, or purchased?
 - **Stewardship tasks:** what activity can be done? Build, help build, prepare materials, prepare the land, measure, supply, clean, etc.



Task characteristics overview

- **Autonomy:** if the task is close enough to their skill level, the team can perform a task without being guided constantly, but rather checked occasionally.
- **Delegated:** led by a more qualified trainee, having sufficient knowledge of the task and the ability to control the work of others.
- **Demanding:** some tasks are crucial for the final quality of the building and in this case, assigned teams must be supervised by the trainer.
- **Judging the size and number of teams.**

The trainer needs to be able to follow the teams' activities and intervene to explain or help if and when necessary. Moreover, there should be enough trainees in the team so they can safely perform the task without excessive effort, but not so many that they hinder each other.



Organize construction materials

- **Two types of storage can be considered:**
 - **Long-term storage** suitable for conservation and restocking.
 - **Short-term working** stockpiles can be placed within reach and remain accessible during the construction process.
They should be as close as possible to the current tasks but in such a way that the stockpiles don't impede work activities, transport, movement, or communication.
- **They can be stored at a greater distance when:**
 - Materials **need to be protected or stored** in special containers.
 - **There are sufficient transportation options**, routes, and transport teams available.
 - **The materials are standardized, clearly labeled, or easily recognizable** (so it's easy to request the necessary type and amount).
- **Generally, all materials on a site should be:**
 - **Sorted** according to their category, size, or any pertinent characteristic that makes them easy to obtain and use.
 - **Labeled** (with names and symbols if necessary) if different types are difficult for trainees to visually differentiate.



The craftsman giving guidelines during a carpentry workshop, Epirus, Greece.



Organize tools

- They should be **sufficient in number** – which doesn't necessarily mean each trainee needs their own tool, but real usage needs should be carefully assessed.

- The **correct use** of each tool must be clearly explained and enforced, so they're not damaged.

- **One or more tool managers** (can be trainees) **should keep track of tools:** they should be accounted for and cleaned at the end of the day.

- They should be **sorted by construction kind** (e.g., timber, stone, brick) and type (e.g., hammers, chisels), and the storage for certain types can be named/labeled.

- They should be **clearly labeled** so as to prevent them from being lost (buried or discarded with building waste) and to indicate ownership.



Checklist for the site manager

- Assess whether the site is suitable for training
- Assess which training tasks can be completed with the given human and material resources
- Define work tasks: different parts of the site, different parts of the process
- Acquire and organize materials
- Acquire and organize tools
- Divide trainees into teams for certain tasks
- Explain training to everyone as well as the construction process, site organization, behavior, and safety rules, and give basic technical instructions
- Explain to individual teams the specificities of their tasks, activities, and techniques required
- Follow the ongoing activities, and control the task performance
- Advise, correct, and encourage as necessary
- Organize site cleaning (each team for their part, more of them together where needed)
- Organize the collection and storage of tools and equipment (every team for whatever is in their domain, the tool manager checks)
- Organize the protection, collection, and storage, as well as removal or disposal of construction materials

4 Acquaintance with materials and tools

Handling and correct use of materials and tools are of great importance for both trainers and trainees. Therefore, a set of procedures and methods/best practices should be applied to avoid common problems that often occur on a site with trainees.

⚠ Most common problems in the field

- **Incorrect and dangerous use of tools.**
- **Use of damaged or defective tools.**
- **Lack of knowledge** about the basic properties of materials and their maintenance requirements.
- **Improper storage of materials and tools.**
- **Trainees leave tools behind that could put their colleagues in danger** (e.g., hand-lifting tools on a ladder, or leaving a tool on scaffolding).
- **Trainees can quickly lose motivation if faced with materials that are difficult to work with (e.g., hard stones) or tools that are difficult to handle, etc.**

💡 Solutions and good practices

- **Inform trainees about the different types of materials** that will be used, their origin, and supply.
- **Have trainees practice on easier and less expensive materials** in order to motivate them, for example, for stone chiseling.
- **Ask trainees to practice with mortars with low binder content** when not working on a real construction/restoration project so that they can be easily dismantled and materials reused.
- **Learn about material properties.**
- **Show trainees how to recognize the good quality of raw materials** (stone, lime, sand, etc.).
- **Consult the technical sheet and safety data sheet of construction products** to know how to store/maintain/handle them correctly.
- **When working with non-certified local materials, ensure there are no safety issues** for trainees and participants, supported by relevant laboratory tests.
- **Organize specialized lectures/presentations/demonstrations/videos** on materials and their historical use/processing (e.g., traditional stone quarrying).
- **Transport and store tools properly** (e.g., use carts or toolboxes for storage under good conditions).
- **Focus on the correct use/handling of tools.**
- **Focus on safety** regarding the correct handling of tools.



Restoring a dry stone hut, learning by doing - Petrebišća, Učka mountain, Croatia



Best practices

- First, **introduce and teach trainees how to use and handle correctly the traditional tools** (chisel, chipper, hammer, hand splitting wedges, etc.), even if trainees will use modern and electric equipment during their careers.
- **Have an exhibition space** with different construction materials for trainees to familiarize themselves with.



Checklist before starting training

- Am I well acquainted with the materials I will use in my next training? If not, where can I find good explanations?
- Have I inspected the tools and materials that will be used tomorrow?
- Do all trainees have their protective equipment?
- Do I have enough equipment for all my trainees?
- Am I aware of all the dangers and safety issues related to the material I will use?

Learning through **action not only allows trainees to acquire essential practical skills but also engages them in a process of critical reflection and continuous learning.**

The trainer **plays a crucial role** in this process, serving as both a technical expert and a skilled educator who can effectively **navigate between knowledge transmission and dynamic adaptation** to trainees' needs.

This pedagogical approach relies on the **strategic use of mistakes as learning tools**, the prioritization of **real-world field experiences**, and the integration of **regular assessments** that guide and adjust the learning path in real-time. These methods are not just educational choices: they reflect a broader philosophy that values competence, autonomy, and individual reflection, which are key elements in the heritage restoration sector.

By adopting an inclusive and well-structured technical framework, this program does not just train competent builders and heritage restorers; it also aspires to cultivate heritage conservators who appreciate the intrinsic value of the sites they restore. Through this dual focus—pedagogical and technical—the training positions itself as a bridge between the past and the future, **ensuring that traditional skills are passed on and adapted to meet contemporary challenges in conservation.**

A theoretical introduction to dry stone walling
Dragodid village, island of Vis, Croatia



2 Obstacles during training

SECTION



Trainer and trainee celebrating a job well done - Konavle, Croatia

When working with people in precarious situations, it's essential to consider the so-called "peripheral barriers to training." **Peripheral barriers are** external challenges that affect the progression of a training process. **They can be related to living conditions, availability constraints, family issues, etc. Even though peripheral barriers are not intrinsic to the training cycle, they have a substantial impact on it and thus need to be addressed.**

As indicated by Maslow's hierarchy of needs theory, a rational individual will not be ready to engage in something else as long as their basic material needs are not met. To successfully train their trainees, the trainer needs to be capable of **recognizing the existence of these issues and addressing them.** This section of the toolbox defines the guidelines that will allow the trainer to recognize the barriers they can and should address. For other issues, the trainer should direct the trainees toward qualified personnel or organizations.



Peripheral barriers during training

1 Peripheral barriers overview

Based on the experiences of the trainers gathered for this project, seven main peripheral barriers have been identified. Among these, the trainees' financial and housing situations can be considered priorities.

	Definition	Examples
Availability	Compatibility between the learner's personal pace of life and the pace of the planned training	Childcare, travel between home and training venue, etc.
Financial situation	Financial difficulties (debts) that may hinder the follow-up of the training	Someone who leaves systematically to fetch alimentary help
Mobility	Difficulties with daily mobility	Lack of public transport, driving license, etc.
Family situation	Close and distant relatives, dependent children, marital status...	School hours that are not compatible with working hours, a trainee that leaves for days to visit his/her family that is abroad
Housing	Unsatisfactory housing/accommodation conditions	Homeless, in emergency accommodation, substandard housing, etc.
Administration situation	Legal situation within the country of residence	Situations about paperwork/residence permit
Health	Diseases, alcohol/drug addiction issues	Trainees that are still drunk or high on the workshop



A master carpenter demonstrating the use of tools in his workshop, Epirus, Greece.



Solutions and means to address peripheral barriers

Providing an income

The organization can address financial and housing issues by providing an income to trainees. Giving an income to each trainee is the simplest way to deal with financial and housing issues. This income grant model can be combined with a productive model, in which the organization creates commercial products, thereby generating profits. ACTA VISTA (France) has chosen to implement this type of support to offer trainees the best possible conditions to follow the training. By signing a contract with ACTA VISTA, trainees receive the legal minimum wage for at least six months. ACTA VISTA has created partnerships with public authorities to offer integration working contracts. Receiving an income is an important value for trainees because many of them have never been employed or have never worked within a legal framework. The status of an employee in an integration process entitles him to benefit from the protections provided by labor law and Welfare State. Trainers have also noticed that providing remuneration gives trainees motivation and a sense of purpose to their work. This income can also be a means to solve problems such as taking driving lessons, finding a decent housing solution, accessing continuing education and unemployment benefits, opening a bank account, etc.

Providing housing

Taking care of accommodation and food for trainees, as well as equipment and tools, is also a step towards inclusive and accessible training.

Boulouki (Greece) opted for this approach, which has demonstrated its effectiveness, especially for small groups of trainees. Moreover, this solution offers the benefit of completely resolving the housing issue. Given the difficulties of finding short-term accommodation for the duration of small-scale construction projects, i.e. one month, the team cooperates with local agents and landlords to provide housing for masons coming from different residential areas. The team advocates within the local communities to obtain housing assistance from local public authorities, municipalities, etc., and to obtain reasonable prices to benefit from this advantage.

Providing external solutions

The training organization should be able to redirect trainees to external assistance solutions, to help them find the solutions most suitable to their situation.



A human chain of trainees for carrying stones on the worksite, Cyclades, Greece.

2 Taking pedagogy into account

Where trainers can't address directly the peripheral barriers, they should focus on training-related solutions, which take into account those obstacles and create a supportive atmosphere for the trainee.

Forming Small Groups

Within the team, mutual aid and awareness towards one another is a good lever. By creating small groups among the trainee team, the trainer will promote peer support. To achieve this mutual awareness among trainees, the trainer can have them explain the workshop or the things they should master better, to each other.

- **Self-explanations within groups**

Being Empathetic

From the trainer's viewpoint, empathy and understanding are essential to put the trainee in a favorable mindset to solve their problems. Even though the trainer is not a psychologist, they must inquire about the trainees' problems outside the workshop and show empathy by demonstrating understanding and support. By organizing a welcome interview and regular check-ins, the trainer shows the trainees that they care about their situation and support them. Nevertheless, the trainer must clarify that they are not the person directly responsible for assisting trainees with their personal issues.

- **Set up a welcome interview and regular check-ins with each trainee**

Being Flexible

Flexibility also proves to have a positive effect on the peripheral issues of trainees. By taking into account the trainee's situation, trainers can adapt their strictness to each personal situation. For example, when a trainee is a few minutes late and the trainer knows they have mobility issues, they might prioritize regular attendance and not insist on punctuality.

- **Adapt rules to the situation of each trainee**



Restoring the waterproofing coating inside a traditional cistern, Cyclades, Greece.

Cognitive skills

This part will focus on a list of key cognitive skills: the core mental capacities including reasoning, memory, attention, and logic. **These skills are essential for processing information, making decisions, solving problems, and executing tasks effectively. As they play a great role in the learning process, trainers can find here practical tips and methods to overcome potential learning barriers related to cognitive skills.**

To build a wall, make paving, cut a stone, prepare a coating, or any other application inherent to the daily practice of the mason's trade of the old building, this knowledge and its uses are essential. Considering that the trainees are adults, it is essential to acknowledge the skills they already possess and which are transferable throughout their training, whether it is academic, professional or coming from their personal experiences.

Indeed, although the list of skills and the pedagogical tools are defined to meet the expectations of the training, **each course must be individualized** since every learner has its specificities in terms of course, learning methods, etc.

A training course is marked by 3 key milestones:

- **The positioning test:** verification of the pre-acquired skills and prerequisites of the trainees
- **In-training evaluations:** formalization of the learners' skills development
- **Final evaluation:** confirmation of the acquired skills

During the positioning test, the trainer must be able to **assess the pre-acquired skills** as well as the knowledge gaps of the learners. This test is precious because it will allow the trainer and the learner to **co-construct** the individualized course.

In the points below, for each of the obstacles identified as preponderant in training time, we have designed tools that will allow you to **facilitate knowledge transmission.**

A trainer helping a trainee to mark stones for adjustments on the Fort St Nicolas worksite Marseille, France



1 Linguistic skills

Miscommunication is a daily occurrence - it's sometimes hard to find the right words even when speaking the same language. We often believe that we have understood what was expected of us, only to realize later that we had absolutely no idea. Not speaking the same language is a real challenge in the trainer-trainee relationship. It can lead to frustration and a feeling of inferiority. At the workplace, trainees who don't fully understand the instructions from the trainer won't be able to perform their tasks correctly. This could result in possible safety issues for themselves and/or others. Ultimately, they don't learn; they just go through the motions.

Explaining through practice and using illustrations are the most effective methods a trainer can use to address the problems that linguistic barriers create in the workplace.

• **Explain visually:** by example or illustration. Make use of the language skills of other trainees.

○ A good solution is to put up **pictures or drawings of the 15 to 20 most commonly used tools** on the wall, along with their names in different languages. This way everyone on the site can understand which tool the trainer is referring to. Moreover, if it is placed in a frequently visited location on the site, it can encourage all trainers and trainees to learn the words for the tools in different languages.

○ Another effective approach is to **teach slowly and repeat** the technique as often as needed. This involves demonstrating the technique, closely supervising the trainee, and promptly correcting any errors while emphasizing hands-on practice.

○ Another method involves **group work**. Trainees who are fluent in both languages can explain to other trainees what the trainer is saying. Everyone can learn a few commonly used words to avoid daily misunderstandings.



A trainer helping a trainee understand text in French
©JC. Verchère

2 Mathematical skills

Before moving to practical exercises, tools, and material manipulation, trainers should assess trainees' ability to master basic mathematical skills.

+ Practice and Use of the Three Basic Operations: addition/subtraction - multiplication - division

Using money:

- "If I want to buy 1 kg of apples for 4€ and I have 10€, how much should the merchant give me back?"
- "If I want to buy 2 kg, do I have enough money?"
- "If I want to equally split apples between 5 people, what quantity will each person receive?"

This exercise can be done with marbles, pebbles, or other small objects to help trainees count.



A group of trainees practicing basic mathematics
©JC. Verchère

Units of Measurement and Their Use

The trainee must integrate the concepts of measuring length and mass. The trainer must ensure and facilitate the understanding of what 1 m and 1 kg represent.

Measurements: using the human body and surroundings

Use your environment and "familiar" elements:

- "How tall are you?"
- What is the distance that separates us from the other side of the room?"

Other measurement systems and site applications:

<p>1 in</p> <p>→ around 2.5 cm</p>	<p>2 in</p> <p>→ around 5 cm</p>
<p>4 in</p> <p>→ around 10 cm</p>	<p>6 in</p> <p>→ around 15 cm</p>
<p>9 in</p> <p>→ around 23 cm</p>	<p>18 in</p> <p>→ around 46 cm</p>

1 step → between 50 and 80 cm

It is also important to provide learners with educational resources such as a unit conversion table so that they fully understand.

Furthermore, this information will be better understood if the learner can visualize the concept.

- 1 m = 100 cm = 1000 mm with a meter next to it for direct visualization
- 1 kg = 1000 grams with a 1kg weight next to it



Trainees taking measures on a wooden formwork
©JC. Verchère

 **Masses and volumes**

This method can also apply to length measurements. Use the surrounding elements and the intrinsic characteristics of the people in training:

- "What is your weight?"
- "How much does a bag of lime weigh?"

Some computer tools in the appendix can be used during theoretical sessions.















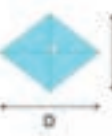

Online mortar and plaster dosage calculator

The trainer can also make this type of support available on their technical platform. The permanent online posting of certain supports allows for anchoring in the learner. The trainer can also use them sporadically and upon request throughout the training.

Liters/volumes correspondence table

m ³		dm ³			cm ³		
		hL	daL	L	dL	cL	mL

Material dosage table for basic mixes

<p>DISQUE</p> <p>nombre pi: $\pi = 3,14$</p>  <p>aire = $\pi \times r^2$ périmètre = $\pi \times d = 2\pi \times r$</p>	<p>SECTEUR CIRCULAIRE</p>  <p>aire = $\frac{\alpha}{360} \pi r^2$</p>	<p>RECTANGLE</p>  <p>périmètre = $2(L + h)$ aire = $L \times h$</p>	<p>CARRÉ</p>  <p>diagonale = $c\sqrt{2}$ périmètre = $4 \times c$ aire = $c \times c = c^2$</p>	
<p>TRIANGLE</p> <p>somme des angles = 180°</p>  <p>aire = $\frac{b \times h}{2}$</p>	<p>PARALLÉLOGRAMME</p>  <p>aire = $b \times h$</p>	<p>LOSANGE</p>  <p>aire = $\frac{d \times D}{2}$</p>	<p>TRAPEZE</p>  <p>aire = $\frac{(B + b) \times h}{2}$</p>	
<p>PAVÉ DROIT</p>  <p>volume = $L \times l \times h$</p>	<p>CUBE</p>  <p>volume = $c \times c \times c = c^3$</p>	<p>PRISME DROIT</p>  <p>volume = aire de la base $\times h$</p>	<p>CYLINDRE</p>  <p>aire latérale = $2\pi \times r \times h$ volume = $\pi \times r^2 \times h$</p>	
<p>PYRAMIDE</p>  <p>volume = $\frac{1}{3}$ aire de la base $\times h$</p>	<p>CÔNE</p>  <p>volume = $\frac{1}{3} \pi r^2 \times h$</p>	<p>CÔNE DE RÉVOLUTION</p>  <p>$g^2 = h^2 + r^2$ aire latérale = $\pi \times r \times g$</p>	<p>SPHÈRE</p>  <p>aire = $4\pi r^2$</p>	<p>BOULE</p>  <p>volume = $\frac{4}{3} \pi r^3$</p>

3 Geometry skills

Among the cases we have identified, we have noticed that some learners do not know or do not possess the **basic notions related to simple geometric** figures such as squares, rectangles, and circles... implying a lack of understanding of the concept of angle and radius, for example.

Providing the trainer with a booklet containing basic geometric figures can already be of great help.

As the training progresses, the trainer will be able to complement the information with notions of angle, surface area, and volume calculation.

As an example of a geometry training exercise, we can use one of the most important basic skills: the drawing of a right angle, for which trainers can use the **3/4/5 method**.

Method for drawing a right angle without a square:

- Draw the first line of 4 m
- With a compass, draw a semi-circle with a length of 3 m from one end of the 4 m line
- With a compass, draw a semi-circle with a length of 5 m from the other end of the 4 m line
- Extend the lines until the intersection of the arcs of the circle

length
width



Rectangle
Surface or Area S (m^2)
 $= \text{length (m)} \times \text{width (m)}$

length



Square
Surface or Area S (m^2)
 $= \text{length} \times \text{length (m)}$

radius



Circle
Surface or Area S (m^2)
 $= \pi (3,14) \times \text{radius}^2 (m)$

height
length



Triangle
Surface or Area S (m^2)
 $= (\text{height} \times \text{length}) / 2 (m)$

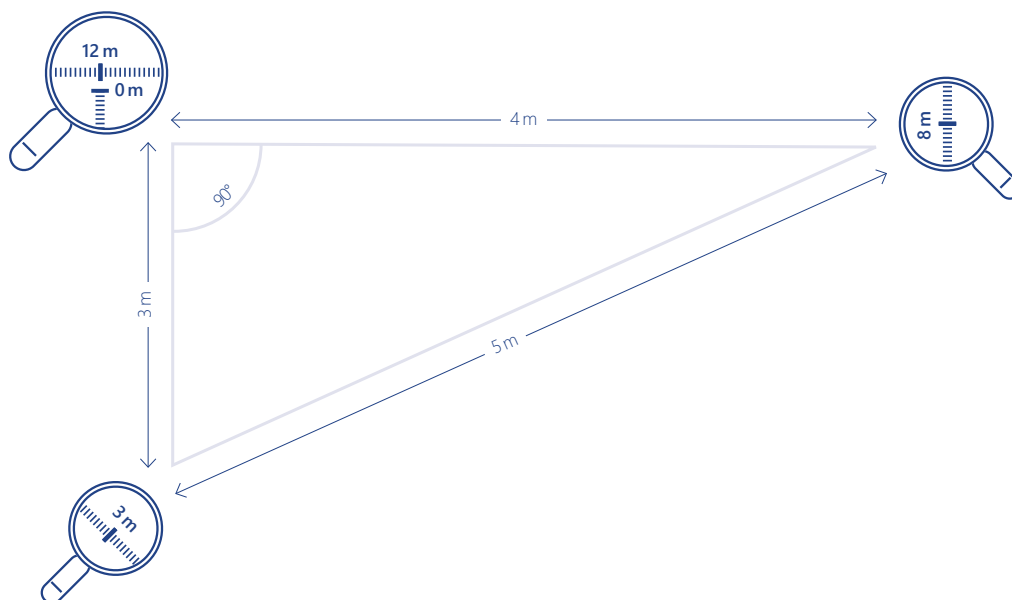

4 Spatial representation and drawing interpretation

Another challenge that needs to be addressed as soon as possible is the ability of learners to **read a blueprint**.

To perform tasks such as cutting or shaping stones, constructing pavements, or detailing complex structures, apprentices must **master the skill of interpreting blueprints**. This involves honing various skills, including those mentioned earlier.

- Understanding the geometric figure
- Understanding and attributing the scale and actual size of the different elements of the given blueprint

As well as:

- Understanding the different views and the information they inherently contain
- Spatial representation

On these last points, tools can facilitate the transmission of knowledge by the trainer.

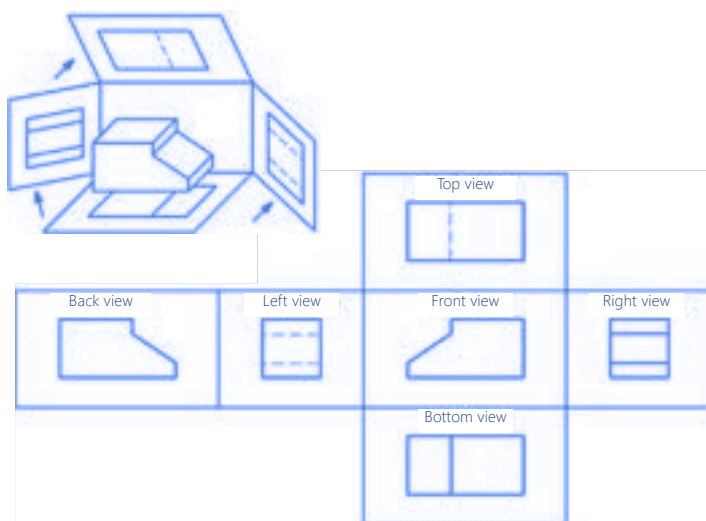

You can start by defining what the left, right, top, and bottom views are, by using the "projection cube" principle:

- The right view is located to the left of the front view
- The left view is located to the right of the front view
- The top view is located below the front view
- The bottom view is located above the front view

To make it more visual for learners, you can do this exercise using elements from everyday life, like the drawing of a human body or a car:



Similarly, the exercise can be carried out with the human body, accompanied by direct questions to the learner:

- Where is your left?
- Where is your right?
- What is in front, back, above, below?

The trainers can also set up **scale models** within their training areas to explain to the learners the necessary steps for the completion of the exercise. This operation is even more effective if the trainer can show a "time-lapse" video, and by stopping it at specific moments, to better illustrate the construction of the model.

Thanks to these tools (scale model and the video), the trainer can, at any time, go back and forth between **what the learner is doing and what should be done.**

In summary, the trainer's toolkit for this part of spatial visualization and blueprint reading is composed of:

- **The projection cube** explaining the front, left, right, top, and bottom views.
- **The visualization of the same cube with familiar drawings** (car, human body...) accompanied by direct questions to the learner: where is your left, your right, etc.?
- **The setting up of small-scale training models** to facilitate the understanding of the construction to be carried out.
- **A "time-lapse" video** allowing the trainer and/or learner (depending on the available means) to freeze the frame and highlight critical points of a construction or specific techniques produced at a given moment.

As always, the trainer must strive to maintain a balance between maximum feedback and the opportunity for the apprentice to experiment and learn from their mistakes.



Sketching on site as a learning method, Epirus, Greece.

5 Advanced cognitive skills

Teaching skills for heritage and modern construction is a long-term process with various stages of learning objectives and difficulties. A trainer needs to keep in mind the... different levels of experience and skill within their team of trainees, as well as to use practical tools to help trainees acquire the basic knowledge they need.

In the previous sections, several pieces of information are provided on how to teach basic mathematical and geometric skills, drawing interpretation, and understanding spatial representation. These skills are essential for engaging in a construction process.

Building upon the aforementioned prerequisites, this toolbox delves into how trainers can assist their trainees in acquiring more advanced cognitive skills.

 **Most common problems**

- *Most beginners **struggle to envision the amount of space or volume** the finished work will take up. Therefore, it's hard for them to determine the resulting construction steps.*

- ***Trainees do not always perceive how important it is to pay attention** to construction details or the accuracy of measurements.*

- ***Trainees need time to practice** which is not always possible, especially when the training process is combined with an actual construction project.*

 **Solutions and good practices**

- ***Use relevant information from the toolbox on inclusive training** in heritage restoration on basic cognitive skills and ensure that trainees practice measurements, leveling surfaces, and reading drawings.*

- ***Use axonometric sketches to illustrate a structure** because they are quite visual and easily understandable. This is an opportunity for masons and architects to collaborate during training and to present different viewing angles as well as the importance of spatial representations.*

- ***Explain the basics of the process** and have trainees practice sketching and freehand drawing as an exercise.*

- ***Adopt a full-scale approach** and invite trainees to visit similar structures/monuments in the area to understand typologies and techniques.*

- ***Map out with trainees the difficult points** of a process or a construction sequence. Identifying and highlighting together possible mistakes can serve as a tool for the learning process.*

- ***Use time-lapse videos** that allow for freeze-frames to explain singular points/areas of caution in a construction.*

 **Best practices**

- ***Use models, 3D models, or scale presentation models.***

- ***Plan specific work areas for trainees,** only for small-scale practice, for example, building small masonry walls.*

Labor law and professional codes

1 Legal framework

In most countries, there is a variety of workplace regulations that apply equally to the employer and the employee to ensure, at a minimum:

- The health and safety of workers and other people
- A fair distribution of work, balancing workload and work efficiency

Beyond this general legal framework, each employment sector or company has its own **professional codes and work culture**. Most companies have their own regulations, whose violation results in sanctions for the worker. However, these formal regulations do not constitute the entirety of the norms that govern the world of work. There are always **informal codes**, in which it is expected that the employee behaves in a certain way, in order to align with the workplace culture of the company.

Workplace behavior is, therefore, the result of the following combination:

- Obligations defined by law
- Company regulations
- Social rules of behavior

Trainees must know and respect both the **legal norms and professional cultural codes** to be prepared for the requirements of any other workplace, as well as for the training process itself. Professional training is also a form of work, whose objective is not necessarily to build something but to succeed in **transmitting knowledge**. Anything that hinders work will probably also hinder training. Training is therefore no less serious than the real work situation, and the trainee who is not able to behave according to the rules will likely be an undisciplined worker.

Among examples of inappropriate behavior, one can mention non-compliance with:

- **Schedule:** being late, stopping work without authorization
- **Work environment:** alcohol intoxication, ignoring tasks and instructions, obstructing teammates
- **Safety:** reckless use of tools and equipment, not using the required safety equipment, not following necessary safety procedures

Rules cannot completely replace the experience and skills required for the trainer to read the group dynamics of the training process. In other words, the trainer should be **more concerned with the intent** of the rule rather than its letter.

2 Best practices

The basic best practices for dealing with violations of the labor code can be categorized as direct and indirect practices.

 **Direct practices are those that demand certain behaviors:**

Explanation
Specify and describe desirable behaviors (how to behave in such and such situation) and explain their purpose (why to behave this way).

Illustration
The consequences of a rule violation - particularly for safety rules (e.g., the impact of dropping a hammer from scaffolding) can be helpful.

Accentuation
Repeat the explanation if behavioral irregularities reoccur with individuals who misbehave, or to everyone if these irregularities are widespread.

Reaction
Gradually introduce a penalty for undesirable behavior; keep in mind that it should not be humiliating for the trainee:

 **Warning**
When the behavior cannot be justified by ignorance of the rules, it is appropriate to warn the trainee that persisting in such behavior will result in sanctions.

 **Request for justification**
If such behavior is repeated but the consequences can still be tolerated, ask the trainee to justify this behavior, to force a moment of introspection.

 **Apply the sanction**
If undesirable behavior is repeated too often or is intolerable, the trainer must apply the sanction provided by the educational institution's regulations; if it is a violation of informal work codes, the usual sanction or the one the trainer deems appropriate should apply, and it should be limited in time (e.g., temporary suspension of a privilege, additional work) and should not be humiliating.

 **Indirect practices are those that create a work atmosphere conducive to rules being respected - a kind of peer pressure:**

Team spirit
Create a sense of unity or group identity, create a sense of belonging and responsibility towards other trainees; this can be done through regular briefings and debriefings, group warm-up exercises, collective organization (ordering, buying, cooking) of lunch, etc.

Feeling of importance
Trainees must feel that their behavior is significant, has an impact, and is important to others. This should encourage them to be responsible. This can be achieved by fostering a sense of equality through collaboration with the trainer or more experienced trainees, and by tactfully encouraging correct behavior with praise and small compliments for their efforts, etc.

Exemplary behavior
Give visible attention to exemplary behavior to motivate other trainees. For example, highlight this behavior during the explanation or accentuation of desired behavior, ask exemplary trainees to explain or demonstrate things, and reward them with symbolic prizes (occasional free time, more attractive tasks, responsibilities...).

When explaining the importance of certain behaviors or the general importance of respecting rules, trainers can **combine their explanations with illustrations** highlighting good behaviors. Those behaviors should be guided by the following principles:

→ **Safety**

Respecting the rules not only protects the trainee but also their colleagues and friends, as well as passersby.

→ **Efficiency**

Rules are created to help trainees complete their training more easily and not hinder others during their training. They are important and beneficial for everyone.

→ **Coordination**

Training is a group activity, so all trainees must act in coordination; individual deviations make this activity more difficult, e.g., not respecting work schedules, falling behind in the training process due to inattention, behaving disruptively, not performing the requested tasks; it's important to keep in mind that individual approaches to learning must be respected as long as they do not harm the group's coordination.

→ **Seriousness and commitment**

The trainee must be ready to work (willing, cooperative, sober) and focused (follow the explanations, instructions, and what others are doing). The trainee will benefit more from the training and internalize a sense of diligence towards work, ultimately helping them to find employment.

→ **Responsibility**

The ability to understand and accept rules shows that the worker can be relied upon.

Trainees working on the upper part of the Fort St Nicolas - Marseille, France



Personal development and empowerment

Professional integration and training are a process of **learning technical skills**, as well as **adapting to different work contexts**, communicating with new colleagues - and most importantly - a process of **empowerment and personal development**.

To train people to become capable builders, trainers must keep in mind the importance of empowerment and personal development. This will be relevant when trainees start working for other companies or create their own activity.

The issues impacting the trainees during their training are lack of autonomy, lack of confidence, and disruption of team spirit. These issues have visible repercussions on the behavior of the trainees. Trainees can become disengaged, tired, demotivated, and lost. Therefore, the trainer should **empower the trainees** and encourage them to **grow as persons**. In that perspective, more experienced trainees can be invited to also **become mentors** for the less experienced ones. Pairing trainees is also a good way to increase their engagement in the training process.

Before starting the workshop, the trainer should talk to the trainee, emphasizing the importance of specific skills and identifying potential obstacles the trainee may face, such as language barriers, motivation, lack of experience, etc. After that, the trainee should **start with a small-scale model** to work with within a given time. This allows the work to be evaluated in 3 steps:

- Step-by-step analysis with the trainer
- Peer analysis with other trainees
- Exchange of practices between the trainer and trainees

The evaluation should be done in a way that not only focuses on the problematic aspects of the trainees' work but also emphasizes their strengths.

→ The **"sandwich feedback"** is a good method of assessment that keeps in mind the personal development and empowerment of the trainee. It is a **constructive feedback** method that starts by praising the trainee for what they did well and the strengths of their work. After that, the evaluator **carefully formulates criticisms** of the work. In the end, it is useful to remind the trainee of the strengths, thank them, and offer them support in the areas which need improvement, to end on a positive note.

Several methods that create an environment conducive to the personal development and empowerment of trainees can be used by trainers. We divide them into individual and collective approaches.

1 Individual approach

The trainer needs to be perceptive enough to **recognize when a trainee needs support**. Upon recognition, the trainer should try to address the issue with the trainee. For instance, if a trainer notices that a trainee lacks confidence or motivation, he must try, during the interview, to **identify the cause and a possible solution**. This discussion can take place during the workshop or at a separate meeting depending on the magnitude of the problem encountered by the trainee.

The trainer can schedule consultation appointments and welcome trainees during the week, as needed, for individual consultation without pressure. These consultations could be used to refresh the objectives of the training and check how the trainee's project aligns with the training they are undergoing. Trainers could also show the **range of professional opportunities** in the sector to boost trainees' motivation.

Each person has different abilities and backgrounds, which require an individual approach. If the trainee has difficulties working efficiently and accurately due to personal development issues, the trainer and the trainee could together **determine small goals for gradual progress**, and go through them step by step. Setting different goals for each person will make it easier for them to reach both small and larger objectives.

2 Collective approach

Creating and maintaining team spirit means creating an **environment of mutual support**, allowing trainees to develop personally through **communication and collaboration** with their colleagues. Team spirit can be strengthened by:

- Group warm-up in the morning
- Collective lunch
- Friendly competition during certain tasks

Creating a moment during the workshop where each trainee explains certain processes on the site, the objectives of the day, or during which everyone evaluates each other's work

After the workshop or after a certain period of work, small rewards can be given individually or collectively to motivate trainees. For example, electing the trainee of the month/day/week, or the team of the month/day/week.

Heritage-related motivation

Trainers should understand that **trainees' knowledge and motivation regarding heritage vary widely**. They also need to be aware that there are several reasons for this.

Trainees may already be aware, possess knowledge, enthusiasm, or deep interest in history, heritage, and environmental issues. Conversely, some may lack exposure to heritage experiences and might be unaware or disinterested, especially regarding their contemporary relevance or environmental implications.

Trainees may come from **different cultural backgrounds**. They may be locals or migrants. They may have different education levels or no education at all. They may be young or old. They may even face issues related to their well-being, such as those mentioned above (financial, health, and other difficulties).

It is up to trainers to help trainees understand the importance of the heritage site they are working on and to be aware of its different features, peculiarities, and histories.

Why?

- To enrich their professional experience
- To create a sense of importance and pride in their work
- To enable them to better understand the culture, heritage, and environment of the region they originate from or where they have come to work
- To help them feel more integrated into their professional environment or local community
- To provoke reflection and questioning about stereotypes and fixed beliefs
- To underline universal values such as freedom, justice, and peace

Practicing on the use of lime-based mortars, Cyclades, Greece.



This can be achieved through **heritage interpretation**. While interpretation is generally associated with visitor management, it can also be the methodology through which a trainer can present the heritage site - the workspace - and explain its importance, stimulate the curiosity of the trainees, or even ignite their passion for heritage as a whole, on a local, national, and international level.

Essentially, interpretation is an educational process that helps to **understand a heritage site and create a connection with it**. Through interpretation, "we engage and empower people to interpret for themselves: by offering pathways to deeper meaning, by transforming phenomena into experiences, by inducing resonance and participation, and by encouraging stewardship of the entire heritage."

To briefly illustrate this process, we present here the approach and tools of the consortium members in this direction:

- **Communicate with the trainees** and give them time to establish a connection with the heritage site they are working on, by presenting a monument/a heritage site/a cultural expression (even a family heritage element, like their grandmother's favorite dish!) that they consider important or of which they are proud. The trainer can even try to establish similarities with the heritage site - the workspace (construction techniques, use of materials, stories, feelings, etc.)
- **Spark their imagination**, thoughts, and feelings using aids such as maps, films, images, music, personal stories, etc.
- **Reveal information empirically**, create opportunities to share experiences with locals who have a connection with the heritage, such as guided site tours, screenings of audiovisual material about the heritage sites in the work area, and informal discussions over dinner.



*Trainees explaining their work to a group of kids visiting the Fort St Nicolas worksite
Marseille, France*

After reviewing various inclusive training methods in the field of heritage restoration and construction for people in precarious situations, it's clear that hands-on training is an effective approach for helping individuals acquire practical skills. This learning method emphasizes field experience and skill acquisition through practice rather than through theory or reading alone.

Hands-on training allows trainees to focus on the task at hand and engage in active learning, which enhances their confidence and self-esteem. Trainers can also take learning barriers into account to tailor their teaching to the individual needs of each trainee, making the training more accessible and effective. Moreover, the participation of people in precarious situations in the restoration of heritage sites can positively impact their **sense of pride**. By offering them the opportunity to contribute to the restoration and preservation of local heritage, they can experience a **sense of belonging** and connection to their community.

This feeling can be particularly important for individuals who have encountered barriers to employment, as it can help them feel valued and respected. Besides the benefits for individuals, training people distanced from employment in construction trades can also have broader positive effects for communities. By **creating local employment opportunities** and preserving local heritage, these initiatives can contribute to strengthening local economies and fostering a sense of pride and identity. On the other hand, it's important to note that construction trades, particularly those related to heritage restoration, suffer from a **shortage of skilled labor**. Training people distanced from employment in these trades can help fill this gap and meet the sector's needs. For individuals taking up these trades, it offers a genuine employment opportunity.

Hands-on training is an effective method for helping those distanced from employment acquire practical skills in the field of heritage restoration and construction. By providing practical learning experiences and involving people in precarious situations in the restoration of heritage sites, we can contribute to fostering a sense of pride and connection to our shared history and culture. This action will **strengthen local communities** and territorial belonging. This training is all the more important as construction trades suffer from a skilled labor shortage, and training these individuals can help fill this gap and meet the sector's needs.

3 Environmental aspects of heritage building skills

SECTION



A drystone pathway and lateral walls interwoven with local trees, Epirus, Greece.

The heritage restoration sector, by definition, is **strongly related to sustainable development**. Restoring heritage buildings means giving a new life to an already built site, reusing its structure and its material, and also applying traditional techniques with limited impact on the environment as compared to modern techniques. This section will provide general knowledge about sustainability applied to heritage restoration. It will offer detailed insights into traditional materials and techniques used in various European regions, along with practical guidance on implementing, planning, and organizing worksites.

Sustainability & heritage : definition & concepts

According to the European Union cultural heritage policies, sustainability is one of the five pillars of the Framework for Action on Cultural Heritage, which addresses the potential to improve networks of relationships, raise economic growth, and restore the environmental balance. Towards the above-mentioned goals, trainers have to familiarize themselves with the relevant terms.

1 Most common problems

To improve awareness about environmental issues and related ecological practices, we provide below a list of which concepts and terminology a trainer should know:

What should a trainer know - basic knowledge regarding the construction sector:

Sustainability

A dynamic process that guarantees the persistence of natural and human systems in an equitable manner.

Sustainable building

Focuses on the entire life cycle of a building or an infrastructure, opting for the use of renewable and recyclable materials that reduce footprint, energy consumption, water, and wastage, in parallel with social and economic sustainable criteria.

Climate change

Refers to any significant change in the measures of climate lasting for an extended period of time. In other words, climate change includes major changes in temperature, precipitation, or wind patterns, among others, that occur over several decades or longer. (according to the Glossary of climate change terms, United States, Environmental Protection Agency).

Carbon emissions

The release of CO₂ (carbon dioxide) into the atmosphere, when referring to the subject of climate change).

Embodied emissions

Emissions associated with the energy consumed in the processes associated with the production of materials and construction throughout the whole lifecycle of a building or infrastructure.

Energy Efficiency

Energy efficiency in heritage restoration involves adopting strategies and techniques that reduce energy consumption while preserving the integrity and historical value of the building. This includes the application of effective insulation methods, the use of sustainable materials, and the implementation of eco-friendly heating, ventilation, lighting, and renewable energy systems.

Life-cycle of building materials

All stages of a product system, from obtaining raw material or generating it from natural resources to its final disposal.

Locally sourced materials

Materials ‘harvested’ from a close-range radius around a construction site, reducing transportation emissions and costs, minimizing environmental impact, and helping to boost the local economy.

Reuse of building materials

Materials obtained from waste after the renovation or demolition of a building or construction, or from the abandonment and collapse of old buildings.

2 Tips for making a worksite and a building project more environmentally-friendly

Material reuse

Preliminary analysis

Before starting the construction work, a meticulous analysis of the materials present on the site allows for the identification of those that can be salvaged. Building materials are identified based on their location, condition, and potential for reuse.

Deposition method

When starting the construction project, a careful deposition of the salvaged materials is recommended to preserve them as much as possible and minimize damage for reuse purposes.

Storage organization

After deposition, the old materials are sorted, cleaned, properly stored, and protected from the weather. They should be categorized according to their type (stone, rubble, brick, etc.) to facilitate their future reuse on the construction site or in other restoration projects.

Preparation for reuse

Prioritize the reuse of old materials on-site before purchasing new ones. They can be used to rebuild walls, facades, or other architectural elements, thus preserving the building’s authenticity and minimizing the footprint and cost of purchasing new materials.



*Restoring a thatched hay roof of a mountain shelter
Petrebišća, Učka mountain,
Croatia*

Screening techniques

Screening is an effective method for reusing materials from rubble. It allows for the recovery of sand and other products such as soil, aggregates, and stones of different sizes.

Use of simple and readily available equipment

For screening, simple and easily available equipment like a grid or wire mesh with different diameter gaps, or specially designed sieves, can be used.

Possible reuses of screened rubble

- The sand recovered from screened rubble can be reused in the preparation of mortars, and concrete.
- The recovered aggregates can be used in drain construction, trench filling, or ground leveling, contributing to waste reduction, transportation, and efficient resource utilization.
- The recovered soil can be reused for surrounding natural terrain or landscaping, offering an eco-friendly alternative to purchasing topsoil.
- The recovered stones can be used for floor construction, masonry, or other architectural elements, preserving the historical and aesthetic aspects of the building.



Stockpile of stones ready to be used on the Fort St Nicolas worksite
Marseille, France

Natural & sustainable materials

Use of natural and raw materials

Prioritize the use of natural and unmixed materials, especially those harvested locally, through sustainable management and/or being by-products of other productive processes, such as agriculture. These materials are environmentally friendly and less damaging compared to mixed industrial materials, ensuring a healthier worksite and the long-term durability of structures. The combination of several natural raw materials on the construction site aligns with the preservation of traditional construction techniques.

Reduction of plastic and synthetic materials

Minimize the purchase of products that harm the environment and human health. Choose environmentally friendly alternatives instead. If necessary, choose products manufactured with recycled or reclaimed materials.

Insulations

Opt for low-conductivity natural materials, such as straw, hemp, reeds, cork, pumice, and wool, either as insulating layers or incorporated in the building materials of the outer shell (e.g. straw in adobe bricks, hemp/rice in the lime plaster, etc.). Also, there are many sustainable choices for insulating layers made out of natural by-products (e.g. wood-fiber board) and recycled plastic.

Waterproofing

Prioritize the use of natural products and study local traditional techniques. For example, a waterproof screed can be made using lime concrete and crushed brick, providing good water resistance while being breathable. Moreover, natural oils, resins and pine tar can be used for wooden surfaces. If the use of a membrane is required, opt for breathable recycled synthetic materials.

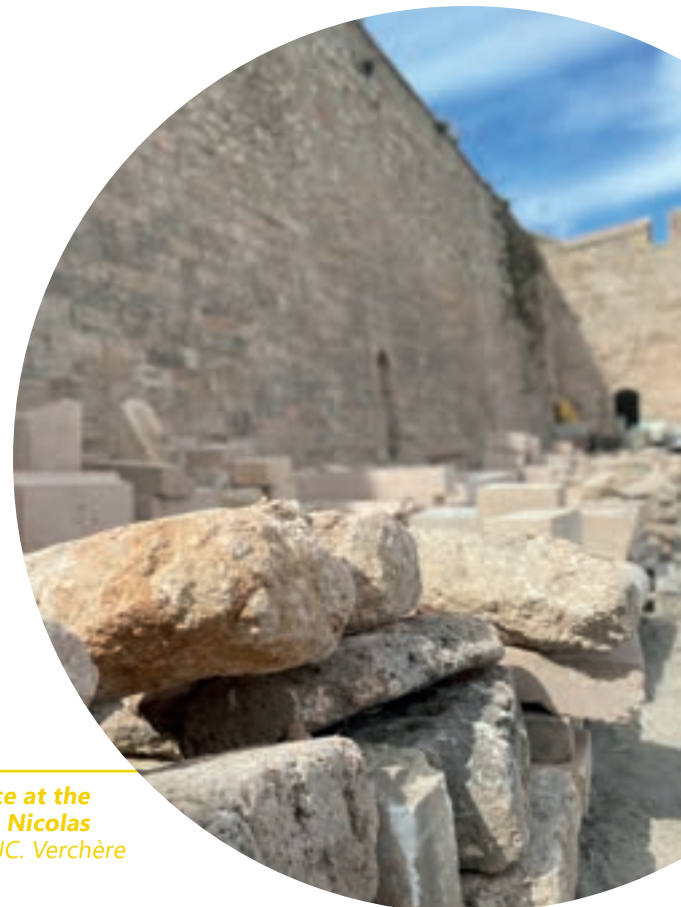

Stone storage space at the back of the Fort St Nicolas
Marseille, France ©J.C. Verchère

Water conservation & recovery

Rainwater harvesting

Rainwater from rooftops, wells, or runoff can be collected thanks to a settling tank. It can be used for cleaning purposes on the construction site and mortar mixing, thus reducing freshwater consumption and contributing to more efficient use of local water resources.

Dry toilets on construction sites

The use of dry or compost toilets significantly reduces water consumption on the site, resulting in savings approximately 9 liters of water per person per use.

Material procurement & supply

Reuse of materials

Prioritize the purchase of materials from demolition or deconstruction, such as stones, bricks, or wood, for restoration projects. This gives a second life to existing elements.

Reuse of equipment and supplies

Consider purchasing equipment and materials from the deconstruction of local buildings, such as cladding, sanitary equipment, electrical equipment, or radiators. This local circulation approach reduces the demand for new products, promotes waste reduction, and decreases carbon emissions associated with transportation.

Equipment repair

Give preference to equipment repair over replacement whenever possible. Repairing equipment contributes to waste reduction and minimizes the environmental impact associated with the production of new equipment. Additionally, construction power tools are often composed of a combination of different materials, making them difficult to recycle.



*Example of a water tank collecting rainwaters for cleaning tolls
Marseille, France*

Reuse & adaptation of materials for educational purposes

Mortar

Create lime-depleted mortars to facilitate the dismantling of educational models, promoting hands-on learning of implementation techniques.

Rubble

Screened and sieved rubble from training exercises can provide the necessary materials for creating new training mortars. This valorizes demolition materials and offers a practical and sustainable experience during training sessions.

Stones and bricks

Dismantle, clean, and reuse bricks and stones in restoration projects to enrich the educational experience and give these materials a second life.

Formwork

After constructing formwork for training purposes, carefully dismantle the formwork to reuse the wood. Nails from the formwork can be removed and reshaped for subsequent reuse. This practice reduces waste and teaches environmentally friendly methods.

Tips for developing an ecological culture on the worksites

Compulsory waste sorting and recycling: Keep separate bins and promote related information to your teams. Have ashtrays everywhere and secure the daily collection of cigarette butts. Reduce the use of plastic bottles and cups as much as possible. If possible, provide participants with refillable bottles and show them water points around the site.

If food is provided onsite, make sure to also propose vegetarian or vegan options. Considering the origin and cultural background of your participants, it's also a good way to avoid potential problems regarding restrictive diets.

Employ manual tools and avoid using electric machines. The manufacturing, use, and recycling of these require a significant amount of energy.

A trainee stocking pieces of wood for future uses
Marseille, France



Environmental aspects of traditional building techniques & materials

1 Stone

Stone has probably been the **most prominent material in historic** and traditional constructions around the world. From monumental architecture to humble yet resilient structures, it boasts a large variation of techniques, intricately tied to each civilization, while reflecting the geological background of each place. Stone has been used in combination with many other materials, mainly earth and lime mortars as binders in masonries, as well as timber and steel as reinforcements. In particular, dry stone techniques rely solely on stone for constructing cobbled paths and retaining walls related to landscape management and agricultural practices or even bridges and entire buildings. The technique is **based only on the use of stones without any binding material** and relies on the proper selection of raw materials and their adequate placement during the building process. It is also intrinsically connected to the available type of stones, which will ultimately define the particular technique and appearance of the structure.

Some **major environmental benefits** of the dry stone structures and techniques are:

- It is a low-cost and low-energy technique that takes advantage of locally resourced materials.
- They are very long-lasting and resilient, as they can adapt to micro-adjustments without developing obvious cracks.
- After being abandoned or unused, the structures leave no harmful waste, instead, they are fully incorporated into the surroundings.
- There are a lot of examples of traditional dry stone infrastructure that are related to water management, aquifer enrichment, and the mitigation of climate change effects, such as soil erosion and landslides.
- They create suitable ecosystems and proper microclimates, providing a natural niche for local biodiversity.



*Trainee practicing stone cutting - ©JC. Verchère
Marseille, France*

2 Earth

There are versatile ways to use clay building products, such as rammed earth techniques, compressed earth block (CEB), wattle and daub, cob, adobe masonry, clay plasters, etc. Each category has different characteristics, properties, and needs for application and maintenance, as well as a different environmental footprint. One should keep in mind that there are **diverse compositions of earth**, with varying clay content and types which will determine the ultimate suitability for construction, depending also on the technique and application. By the same token, there is a need for **scientific analysis and testing** before the use of an earthen material in an actual construction project, to assess its quality and performance, as well as health-related issues.

All over Europe and the Mediterranean, different techniques have been developed according to diverse geological deposits, different climatic conditions, architectural needs, and technologies.

There are, however, some general approaches to the **environmental benefits of clay-based materials** that a trainer on heritage restoration and ecological architecture should keep in mind:

- Earth can be locally resourced and, depending on the ultimate building product, can have minimum processing, minimum embodied energy, and carbon footprint (i.e. the case of unsterilized unfired clay bricks).
- It contains zero volatile organic compounds (VOCs) and creates an overall healthier indoor air quality, due to its moisture buffering properties.
- Earthen building materials are characterized by good thermal and sound insulating properties, thus reducing the energy demands of a building related to heating/ cooling.
- A significant amount of excavation soils can be reused after proper assessment and minimum processing. Instead of ending up in landfills, excavation waste can be reevaluated as construction materials.
- Earthen materials and structures, after being abandoned or no longer usable, will simply disintegrate and merge with their environment. As top materials in the cycle (cradle to cradle model), all earth materials can be recovered and returned to earth without any action.



*Trainees levering earth soil on the access ramp of the Fort St Nicolas
Marseille, France*

3 Lime

There are **two major categories of lime binders** used in architecture, depending on the geological origin and purity of the limestone:

→ **Air calcitic lime**, which is produced by the calcination of high calcite content limestone and hardens in contact with the CO₂ of the atmosphere. Quicklime is produced after the limestone burns and is reacted with water (slaked) to form calcium hydroxide [Ca(OH)₂], which is known as Hydrated Lime (HL). Hydrated lime is commonly available as a fine dry powder. It can also be a thick paste known as lime putty, or a liquid suspension known as milk of lime. Historically, lime putty was widely used as a binder in many historical buildings in Europe and the Mediterranean.

→ **Hydraulic lime** is produced by the calcination of limestone rich in silica impurities, giving calcium/silica compounds. When the quicklime is converted to hydrated lime after reacting with water, these compounds form part of the product with the remainder being calcium hydroxide. Calcium/silica compounds are capable of a cementitious reaction with water so that when the lime is used in mortar, the mortar will set and harden "hydraulically", that is by reaction with water. The remainder of the hydrated lime will harden slowly by reaction with carbon dioxide in the atmosphere. This type of lime gives advanced water resistance properties to the final building material.

Different applications of lime building products can be detected in historical structures. Plasters, binding mortars, concrete, and special applications such as murals and decorative elements have been applied in long-lasting structures worldwide. Nowadays in Europe, all



Quicklime slaking to produce lime putty

types of building lime that are used in the building sector are **certified according to EN459**. This describes all the different types of commercially available products and their specifications for quality control and proper application. Some of the environmental benefits of the use of lime, especially the air-hardening type, are the following:

- They are vapor permeable and allow buildings to breathe. This reduces the risk of trapped moisture and consequent damage to the building fabric but also enhances the indoor air quality.
- Lime has less embodied energy than ordinary Portland cement (OPC).
- Free lime absorbs carbon dioxide while it hardens. The lime cycle depicts the process of how the binder is produced and sets in the construction, minimizing the CO₂ footprint
- It is possible to produce lime on a small scale. There are cases in Europe where traditional lime production has revived, thus historical craftsmanship in raw materials processing can be safeguarded.
- The gentle binding properties of air lime enable full re-use of other materials, such as sand and gravel.
- Small quantities of lime can protect and be combined with very low-energy materials such as earthen building products and straw bales.

4 Wood

Wood has long served as one of the most prominent building materials related strongly to heritage. It is also promoted as a **sustainable alternative to concrete and steel** across a wide range of applications and scales.

Traditionally, timber has been used for various **structural applications**, combined with other building materials, such as stone and earth. It is used mostly as **reinforcement** in masonries and of course, as the main structural element for roofs and terraces. In some cases, buildings can be made out of wood, usually in areas close to forests. Moreover, wood has been extensively used in construction for various non-structural elements, such as openings, light-weighted internal walls, and false ceilings. Its **high mechanical strength** and numerous possible applications, combined with its **negative carbon footprint**, have proved timber and its products as an outstanding solution not only for heritage projects but also for decarbonizing the contemporary construction sector. Some of its main environmental benefits are the following:

→ Wood is renewable and special attention should be given to buying wood that has been harvested sustainably (see FSC- Forest Management Certification).

- It can be reused and repurposed for centuries if properly managed.
- Trees absorb CO₂ and wood holds it in, making possible a carbon-negative building material, depending on the processes involved in its production and transport.
- Wood can be recycled and its byproducts, from forest harvesting (e.g. bark) to processing (e.g. shavings) can be used as the main material to produce other building materials (e.g. MDF, OSB, Wood-fiber board) or even biofuel.
- It's fully biodegradable, especially if no synthetic binders or chemical treatments have been used in its manufacture.



A stockpile of wood ready to be used in the Fort St Nicolas Marseille, France

5 **Natural fibrous materials**

Since ancient times, natural fibrous materials have been added to different mixtures to **enhance the properties of building materials**, or in autonomous applications. Until the middle of the 19th century almost every single building was made mainly of natural materials, mostly wood but also various natural fibers. Diverse raw materials such as wool, goat hair, cotton, hemp, straw, reeds (bamboo, cane, and totora), sisal, kenaf bast, jute, flax, kapok, coconut fiber, and others have been used worldwide in versatile applications, depending on the local availability and cultural conditions. Today, they offer great potential for architecture and design. Some main environmental benefits that are associated with these materials are:

→ They are fast-growing, locally resourced, and available in large quantities (agricultural waste)

- They can be utilized from agricultural waste material (recyclability) and therefore reduce landfill waste
- They are low-cost, lightweight, and renewable
- They can absorb CO₂ (low environmental impact) from the atmosphere while growing
- They offer attractive surface aesthetics and versatile applications
- They have multiple functional physical and mechanical properties, i.e. for thermal insulation, acoustic applications, hygric behavior and fiber-reinforced composites (improved strength, lower shrinkage and crack formation)
- They are easy to handle/use and with little to zero impact on the user's health
- They are biodegradable (at the end of their life cycle) and do not produce toxins or other pollution



A ceiling made of reeds and seaweed in a traditional house of Cyclades, Greece.

Traditional building techniques for tackling water scarcity

1 Example of the Santorini Archipelago

In the volcanic land of the Santorini Archipelago, most public cobblestones functioned **in connection with water collection infrastructure**, and cisterns, traditionally waterproofed with lime and local natural pozzolan mixture ([theran earth](#)). Locals indiscriminately use the terms “road” and “river” to refer to the pathway, as it functioned as a river’s bed with the seasonal flow of the streams, redirecting water to the cisterns.

A restoration project ([Under the Landscape](#)) that took place in the cave settlement of Agriia in 2021 aimed at reinstating the functionality between the cobblestone and the cisterns for water management, contributing to the research of how traditional solutions can assist in tackling water scarcity.

2 Example of Paros Island

Micro-dams technique (see relevant [project in Paros, Greece](#)) constitutes a traditional practice for **water management**, implemented inside streams and riverbeds. Their values are multi-fold:

- They reduce the stream bed’s slope and small amounts of water are collected for irrigation purposes.
- They enrich the aquifer by reducing the flow velocity of water and retaining part of it, increasing its penetration into the ground.
- During periods of heavy rainfall, they retain significant quantities of water and sediments, thus reducing the risk of flooding in settlements, which are usually located in coastal areas at the river streams’ end.
- They are hotspots for biodiversity: the shallow water reservoirs they create are small oases for arid island ecosystems, particularly during periods of drought.

A traditional cistern used for water collection and storage in the arid land of Cyclades, Greece.



3 **Example of small freshwater ecosystems in Croatian Karst mountains**

The Karst area of the Croatian landscape makes up about half of Croatia and is especially prominent in the Dinaric Alps, as well as throughout the coastal areas and the islands. It is formed from the dissolution of soluble stones such as limestone, dolomite, and gypsum. In places where water is already present to some extent due to the morphology of the relief and types of soil that cause slower runoff and sinking of water, local communities arranged ponds and wells - facilities for water accumulation and use.

Freshwater ecosystems created by hand serve as a **water supply** for people and their livestock. They are watering places for wild animals and places of **rich biodiversity**. The karst mountains have been used for grazing for centuries, but in the last few decades, there has been a large decrease in the number of inhabitants, as well as the loss of agricultural infrastructure. [Still Water Revival \(2022-2025\)](#) is a project dedicated to restoring freshwater ecosystems in the Croatian karst mountains to support the preservation of water and biodiversity, but also to promote agricultural activities in these areas.



An "after" photo of a restored dry stone well
Village Čubrice, Dinara mountain, Croatia

CONCLUSION

Making the construction and restoration industry more inclusive and sustainable is a real challenge but also a great opportunity to innovate and try new approaches. Progress can be achieved at every phase of the construction and restoration process (design, planning, organization, execution, exploitation...) but also at the individual level for everyone involved (architects, engineers, worksite managers, team leaders, technical trainers...).

Historical sites are particularly conducive to innovation in this sector: they combine sustainable features that are inherently linked to the traditional techniques employed in their construction which are then repurposed for their restoration. Furthermore, they serve as prestigious and appealing educational platforms particularly beneficial for vulnerable people looking for professional opportunities.

The societal challenges linked to the climate crisis and the European socio-economic context, make these developments necessary. The policies initiated by the European Commission, such as the Green Deal and the New European Bauhaus, provide an interesting framework to enable stakeholders in this sector to address these issues and provide solutions.

We hope that this toolbox will give the reader a better understanding of the sector's challenges and provide key insights for addressing them. The content is not exhaustive, but it has the merit of compiling expertise and best practices from the field that can be easily implemented. The toolbox also does not constitute a set of rigid instructions, but rather a range of solutions from which professionals can draw to adapt to the specificities of their projects and their audiences.

Restoring a dry stone hut, learning by doing - Petrebišća, Učka mountain, Croatia



Technical annexes

Annex 1 - Trainer self assessment grid

	<i>This statement is</i>	True	Partly true	Partly wrong	Wrong
Expected vs Achieved	<i>There is no difference between what was expected and what has been achieved. No mistakes or omissions. The whole process was respected and completed.</i>				
Group cohesion vs dispersion	<i>Group cohesion was excellent, The atmosphere was characterized by mutual support and cooperation, and no trainee was excluded. There was no conflict or negative remarks between trainees.</i>				
Clear and understandable explanations	<i>Explanation were clear. All trainees understood what they were expected to do. Results, achievement and answers given by the trainer show that everything was understood.</i>				
Trainees involvement	<i>Trainees showed active involvement and interest by asking questions and further explanations. They took notes and expressed critical feedback.</i>				
Material difficulties	<i>Material was no issue, everything worked well on the first try. Material conditions had no negative impact on the pedagogy.</i>				
Memory loss	<i>The trainer told everything he had to, there was no omission. All the preparation work, notes and support documents were relevant.</i>				
Group management	<i>There was no excessive talkings that could show low interest or irrelevance of the activity, a low level of preparation or a non adapted training format. The disruptive trainees were effectively managed and their individual behaviors did not have any negative impact on the progress of the training.</i>				
Relevance of the activities	<i>Pedagogical activities were well designed, adapted and relevant for the trainees. Trainees accepted the proposed activities. Activities were implemented without problem and reached the pedagogical objective.</i>				
Trainees mood	<i>Rythm, amount of new information, progressivity, schedule and breaks were adapted to fit the group's needs.</i>				
Pedagogical material	<i>Pedagogical material were delivered at the good moment. It has been useful and was well assimilated. No material has been "forgotten" by any trainee after the activity.</i>				

Annex 2 - Developing a methodological framework

Setting learning objectives

The objectives can have different time frames, ranging from an hour to a day, a week, a month, or the duration of the training. Each objective should be chosen in accordance with the pedagogical alignment.

Possible reuses of screened rubble

- ① **Clarification**
What learning outcomes are we aiming to evaluate?

- ② **Observation**
How to obtain proofs of learning?

- ③ **Interpretation**
How to analyse proofs of learning?

Evaluating the achievement of learning objectives

This process requires the trainer to follow certain steps.

Before creating analysis grid

Explicit learning objectives and their respective weight

- ① **Step 1**
Identify and describe precisely the evaluation dimensions and criterias

- ② **Step 2**
List the performance and achievement indicators

- ③ **Step 3**
Establish the assessment scale

- ④ **Step 4**
Comment and make observations



Trainer explaining stone cutting to a trainee on the Fort St Nicolas - Marseille, France ©JC Verchère

To go further

Pedagogical approach and theoretical foundations

1 Founding references

To begin with, our approach is based on some "main principles", which go far beyond the framework of pedagogy and instruction. Indeed, outside of the teaching theories that will be discussed later, the approach championed here is first and foremost a "philosophical" choice, a way of "seeing the world".

It is mainly based on two 20th century schools of thought, namely:

The systemic approach (The Palo Alto school)¹

The works of the Palo Alto School demonstrate that the world is made up of multiple relationships and everything is interconnected. The individual, the company or any other subject is part of a global system, itself comprising other subsystems, the whole being in an interdependent, permanent and changing relationship.

From this notion we can see that a system can only be understood as a whole and not in a fragmented way disconnected from its environment. Moreover, this system itself has an identity, properties, values and a trajectory that may differ from what each of its constituent parts has, that is to say, a whole that is not the simple sum of its parts, but a whole that is a system with its own identity and functioning (holism)².

What this means for teaching:

According to the systemic approach, the individual (the learner) must be considered as a whole, taking into account his or her links with the system in which he or she evolves. In other words, the learner is not just an individual who has to acquire knowledge during a teaching session. He or she is an individual with a life made up of interactions and experiences which influence who he or she is and therefore his or her ability to learn. For the trainer, this raises the question of how to take into account the relevant obstacles (peripheral and direct) to learning.

Holism postulates that a group of learners will develop its own identity and 'force', which will be unique and different from the sum of the 'forces' deployed by the individuals who make up the group. This is a dimension that the trainer should not neglect during implementation in order to maintain the dynamics of his or her group of learners and the individuals within it.

[1] The Palo Alto School: Founded in 1952 by the anthropologist Gregory Bateson, this research centre located in Palo Alto, California, aimed to study the "paradox of abstraction in communication".

Their work laid the foundations for a new way of thinking about the world. This was made possible by the transition from a mechanistic vision, where things are identified, compartmentalised and governed by determinism and causality, to a vision of the world where things are open, interconnected and give access to an infinite field of possible combinations.

[2] Holism is: "The tendency in nature to constitute wholes that are greater than the sum of their parts, through creative evolution. (Smuts, 1926). The system is open and interacting, but it also has a 'force' of its own.

Complexity and complex thinking (Edgar Morin)

Developed by Edgar Morin³, complex thinking is defined as the ability to consider the system in all its complexity, welcoming its paradoxes and taking into account the heterogeneity of those who compose it. It means not excluding anything, but integrating everything, including that which seems dissonant or even contradictory.⁴

It also means considering the randomness, the uncertainties, the 'noise', transforming it from a dissonance or an error to be eliminated into data that allows the system to be questioned, opening up a space for reflection, in search of a new path. It means accepting imprecision, inadequacy, vagueness and unclear areas. It is the ability to work without knowing everything and with the awareness and acceptance that everything will never be known. Complexity 'is uncertainty within richly organised systems' (Morin, 2005).

Complex thinking also means recognising disorder (entropy) as an expression of the living, as it triggers a process of adaptation of the system (negentropy) to a changing environment ("the laws of organisation of the living are not of equilibrium, but of disequilibrium" (Morin, 2005).

What this means for teaching:

Complex thinking asks of the trainer that he/she should not reduce his/her understanding of things, nor his/her way of acting. Rather, everything, even the seemingly paradoxical, should be considered as a possible option for educational intervention. And that faced with a complex and constantly changing situation, the trainer will have to mobilise different approaches and tools, test them, question their impact and adapt his or her practice. Like the learner, the trainer is also in a permanent learning process, where he or she will encounter grey areas, test out methods, make mistakes and thus develop his or her skills in a sort of "creative disorder".



**Trainee and trainer laying stones on the Fort St Nicolas
Marseille, France**

[3] Edgar Morin is a French sociologist and philosopher (1921). A sociologist of complex thought, he defines his way of thinking as "constructivist". He is also known for his political commitment to communism and later socialism.

[4] Complex thinking leads us to consider opposites and oppositions in order to integrate their paradoxes into a way of thinking that embraces the system, the situation, the subject, the object, in all its complexity ("The 'either/or' is replaced by both an 'either/nor' and an 'and/and'") (Morin, E. (2005). Introduction to complex thinking. Paris: Editions du Seuil).

2 The main currents in learning theory

The aim in this section is to present a brief introduction to the main currents which constitute the basis of the theoretical framework of trainers.

This brief presentation is not intended to lead the reader to believe that there are good and bad ways of training. Rather, each of these approaches has its own benefits and limitations, and they are all considered to be useful to the trainer, enabling him or her to create his or her own pedagogical "toolkit".

Learning is passing on: behaviourism

Behaviourism is a concept that focuses on the idea that behaviour is learned through interaction with the environment. Behaviourism defines learning as a lasting change in behaviour resulting from the consequence of a particular training.

Burrhus Skinner⁵ developed the concept of "operant conditioning" ("behaviour can be structured by the appropriate use of appropriate conditioning").

Skinner states that learning can be achieved through the use of rewards called "positive reinforcers" (e.g. good grades in students) and punishments called "negative reinforcers" (e.g. bad grades in students).

In this sense, the individual adopts a behaviour that allows him or her to avoid negative reinforcement and to increase the chance of obtaining positive reinforcement.



Trainer and trainee practicing traditional stone extraction in the riverside, Epirus, Greece.

In its application, this model is based on the following principles:

- The material to be taught is broken down into a series of short elements to allow for the fastest possible reinforcement.
- The content starts from the simplest level and the level of difficulty increases gradually to promote error-free learning.
- The content is presented in a linear fashion, but everyone is free to work through it at his or her own pace, thus individualising teaching.
- Positive reinforcement (through encouragement, etc.) is favoured and should be given as soon as possible.

[5] Burrhus Frederic Skinner (1904-1990) was an American psychologist and thinker. An influential figure in behaviourism, he was strongly influenced by the work of Ivan Pavlov and the behaviourist John Watson.

● **Learning is processing information: cognitivism**

Cognitivism focuses on the internal processes of the learner and the connections that take place during learning.

Cognitivism holds that the 'black box' of the mind must be opened and understood. In other words, the learner is a processor of information and knowledge is a pattern of mental constructs.

Learners are active participants in the learning process. Similarly, they use various strategies to process and construct their personal understanding of the content. Learners are no longer just recipients who are filled with knowledge by teachers, but they are active participants in learning.

This is a dimension that the trainer will be concerned to stimulate, in particular by organising the learner's schedule in a way that allows the learner to activate his or her own cognitive resources. The trainer can use this process to facilitate the learner's educational progression.



Trainees measuring the level between two pillars
Marseille, France

● **Learning is building: constructivism**

For Jean Piaget⁶, learning is the construction of knowledge in the course of one's own biological development. Each subject acquires mental tools that enable him to understand the world in which he or she evolves and to appropriate it. It is because the subject is active that he or she acquires knowledge.

Necessarily, the acquisition of knowledge implies the activity of learners through the manipulation of ideas and concepts. The individual becomes an active protagonist of the cognition process.

The constructivist model considers "learning" as the result of a construction of knowledge. In learning, it is therefore necessary to place oneself in active situations of trial and error in order to encounter and solve problematic situations.

[6] Jean Piaget (1896-1980) was a Swiss biologist, psychologist, logician and epistemologist known for his work in developmental psychology and in epistemology through what he called genetic epistemology. His work sheds light on 'intelligence', understood as a specific form of adaptation of living beings to their environment, on the stages of its evolution in children and his theory of learning. This insight has had a significant influence on pedagogy and educational methods.

● **Learning is exchange:
social constructivism**

According to this theory, developed mainly by Vygotsky, learning is seen as the result of activities linked to exchanges between teacher/learner and learner/learner.

Learning is no longer considered merely as what the teacher imparts and what the learners do, but learning is also the interactivity between learners themselves, as well as between teacher and learners.

In order to acquire knowledge, it is then necessary for learners to carry out tasks at a higher level than what they are currently capable of. Through imitation, in a collaborative activity, under the guidance of teachers, the learner is able to achieve much more than he or she is able to do independently.

Beyond the acquisition of new knowledge, social cooperation allows the learner to develop several intellectual functions: attention, memory, abstraction, the ability to compare and differentiate, etc.

The trainer can conduct this process by setting up participative workshops, work groups, collaborative work, face-to-face or group exchanges, etc.



**Participants studying
a traditional cave
dwelling in Cyclades,
Greece.**

[7] George Siemens (Canadian learning theorist) and Stephen Downes (Canadian computer scientist) have developed a theory of learning called connectivism which uses the network principle as the focus of learning, focusing more on making connections between knowledge.

3

The learning process under scrutiny

These theories relate to general concepts with which the various protagonists of the teaching sessions will have to deal with. This is where the learning process will come into play, with subjects adopting different stances and using a wide range of possible tools.

The learner and autonomy

The work of Jacques Ardoino⁸ highlights the different "stances" that learners can adopt. In a complex and changing environment, education is bound to evolve and its meaning may be called into question. The learner's autonomy then becomes an asset in his or her ability to decide and act in a specific situation.

Ardoino identifies three types of learner:

→ The "agent" is the one who acts, applies the rules, without disputing or questioning them. He or she is totally oriented towards the accomplishment of the task assigned to him or her and the objective that has been set.

→ The "actor" performs his or her role within the framework given to him or her and according to the procedures imparted. On the other hand, he or she will do things "his or her own way". Even if he or she acts on the way things are done, he or she does not become a creator, the author of something new.

→ The "author" is the one who "authorises him or herself", i.e. who has the intention and the capacity to place him or herself at the origin of his or her acts. He or she thus claims the legitimacy to decide certain things for him or herself.

Whilst a progression from less to more autonomy can be identified from these three positions, it would be simplistic to consider the roles as fixed and unchangeable. In any given situation, each learner can adopt one or other of the roles and alternate them according to different parameters, such as his or her mastery of the subject, environment, current state of mind, etc.

This being the case, guiding the learner towards autonomy remains a major objective for the trainer.

[8] Jacques Ardoino (1927-2015) was a French pedagogue and professor of education at the University of Paris 8. He is the author of books on education and was one of the first to theorise the role of the professional coach.

● The particularities of adult education

Andragogy is the practice of adult education. It refers to the set of techniques for imparting knowledge, educating and training apprentices and workers. This concept was mainly developed by Malcolm Knowles⁹.

Andragogy is premised on the fact that adult learning has its own characteristics:

- Adults do not have the same capacity to memorise information
- Adults do not accept ready-made ideas, they have to be convinced
- Learning challenges pre-established certainties. This can be a difficult experience.
- Adults come with a history, with his or her own experiences which can be built upon
- Adults have a more developed critical mind

In response to these observations, andragogy provides a model enabling the trainer to deploy an adapted and relevant pedagogy. The trainer can then apply several mechanisms:

- Supporting motivation through want and interest (desire)
- Adults focus on the concrete (what is it for?)
- Considering experience (barrier or resource)
- The need for autonomy (reflexivity)
- Taking into account the heterogeneity of the adult group (interpersonal differences)
- The training must be based on real-life elements to elicit the active participation of the adult learner.

[9] Malcolm Knowles (1913-1997) was a pioneer in adult education. He developed an adult education model that takes into account the specific characteristics of the adult in the learning process. This approach is part of the current of contemporary humanism which developed in reaction to the behaviourism which prevailed during the first half of the 20th century. Malcolm Knowles, Carl Rogers, and Abraham Maslow are the forerunners of this trend, which advocates learning in an autonomous way with an essential consideration of affective and cognitive needs.

The educational relationship

In his model of pedagogical conception, Jean Houssaye¹⁰ defines any pedagogical act as *'the space between three vertices of a pedagogical triangle: the teacher, the learner and subject matter'*.

This model tends to illustrate how the relationship between the subject matter (the content of the training), the teacher and the learner is organised: the "learner" learns the "subject matter", the "teacher" teaches the subject matter, the "teacher" teaches the learner.

Jean Houssaye points out that, as a general rule, a pedagogical situation favours the relationship of two out of three elements of the pedagogical triangle, in which case the third element is "dead". For example, traditional teaching will tend to privilege "subject matter" to the detriment of the pedagogical relationship ("teaching") with the learner. Conversely, a highly developed pedagogical relationship ("teaching") will sometimes tend to neglect the teaching of content ("subject matter").

The Jean HOUSSAYE triangle

It is by considering these different relationships that the trainer will be able to implement the necessary steps to stimulate or activate the relevant behaviour: "teaching behaviour" (transmitting knowledge), "training behaviour" (building a relationship of exchange), "learning behaviour" (providing the learner with sources of knowledge), etc. As before, none of these should be considered more effective than the others and all are necessary for a balanced pedagogical relationship.

Assessment as a learning tool

Although it is often forgotten, **assessment is an integral part of the educational process and a learning tool.**

It is generally agreed that there are three main models of educational assessment:

→ Predictive assessment:

This is the evaluation of the learner's level before entering training. It means conducting a diagnosis to check whether the necessary prerequisites for joining a course are present. The trainer will also use it to assess the level of a learner, in order to adapt his or her work to the intended educational progression.

→ Formative assessment:

This takes place during the course of the training, in order to assess what is working or not for the learners, the degree of acquisition of skills as regards the objectives set, etc.

→ Summative assessment:

This measures learning outcomes at the end of the course, in order to certify that the course objectives have been achieved.

To this we could add a fourth category of assessment: formative assessment. The learner, accompanied by the trainer, evaluates his or her results, as well as his or her performance, and takes a critical look at them. The moment of assessment then becomes a pedagogical process enabling the trainer to guide the learner in a reflective analysis of his or her practices and to lead the learner to consolidate what he or she has learned, to identify his or her mistakes and to respond to them through his or her own reflection and learning process.

[10] Jean Houssaye is a professor of educational sciences at the University of Rouen. He has formalised the famous "pedagogical triangle" (subject matter / teacher / learners) and published an authoritative summary of the subject "La pédagogie: une encyclopédie pour aujourd'hui".

● Educational progress

In his or her relationship with the learner, the trainer will be concerned to monitor the learner's educational progress. This is the learner's ability to acquire the knowledge covered by the training. Some of this knowledge is more complex and needs to be progressively built up. This must also take into account the learner's own pace of acquisition.

Bloom's¹¹ Taxonomy is a model for defining the level of skill acquisition and for the trainer to adapt his or her teaching approach.

It organises the information in a hierarchical fashion, from the simple restitution of facts to the complex manipulation of concepts. By dividing the progression into graduated sequences, we are using an objective-based teaching approach, where we build on what is easy to grasp and then move on to more elaborate mental constructions.

The trainer will then ensure pedagogical alignment, allowing the coherence of the structure of a teaching session or course between the objectives to be achieved and the activities put in place in order to reach these objectives.



A trainee laying tiles on the roof of the Hôpital Ste Caroline Marseille, France

To conclude this theoretical section, it should be remembered that the models presented here are in no way to be considered as dogma to which the trainer must imperatively submit. As complex thinking teaches us, there is no definitive choice to be made between one approach or another. It is by considering all the options, by applying them to a given situation, by creating links between them, that the trainer will be able to develop an approach that is adapted to the situation and makes it possible to individualise learning.

Armed with these concepts, it is now up to the trainer to devise his or her own pedagogical approach and create his or her own " toolkit ".

[11] Benjamin Bloom (1913-1999) was an American educational psychologist. He was also a teacher, researcher, literary editor and examiner. He is best known for his important contributions to the classification of educational objectives and for his Bloom's Taxonomy, which is useful for assessing learning progress.

Activity sheets

1 Introducing HERO content to trainers

[See video on youtube](#)

This activity is designed to introduce HERO related contents (inclusive pedagogy and environmental dimension on heritage restoration worksites) that can be proposed at the beginning of the process. This activity relies on role play and improvisation theatre in order to slowly dive into HERO's toolboxes content.

Each group will be given a short scenario picturing a common scene that can happen on a restoration worksite (ex : participant not wearing hard hat). Participants will have to prepare a short theatre play for the rest of the participants to present how they would solve the problem. An open discussion can follow to discuss the solution presented.

1 Pedagogical Objectives

- Common problems in working with vulnerable participants
- Inclusive pedagogy and methodologies
- Environmental aspects of heritage restoration

2 Technical Framework

 **Duration:** 1h to 1h30

 **Participants:** 6+ (divide participants in smaller groups of 2 or 3)

 **Materials:**

- Prepared scenarios (see below)
- Post its
- Pens
- A board, paperboard or any surface to stick post-its

3 Instruction

- **Introduction:** the facilitator asks participants to write on post-its 3 keywords related to the notion of "technical training on heritage restoration worksite" (ex : a value, a competence, a point of attention etc ...). Post-its are then pinned on the paperboard. All together, the post-its will list the "ideal profile" of the technical trainer.
- **Groups set up:** Divide participants in smaller groups (2 or 3) and give them a scenario to prepare.
- **Preparation:** Give each group 10 to 15 minutes to prepare the theatre play.
- **Presentation:** Each group has about 5 minutes to present its theatre play.
- **Contextualisation:** After each presentation, the facilitator recalls the scenario, the problem and sums up the solutions and techniques used.
- **Follow-up discussion:** The facilitator then asks for comment and feedback from the other participants (What did they think of the solution? / Did they already face this problem and how did they react? How can we improve our methods to better deal with these kinds of problems? etc ...). This is repeated and adapted for each scenario.
- **Wrap-up:** Once every group has presented its play, the facilitator recalls the main topics raised from the discussions. Those topics are then put in perspective with the content of HERO toolboxes, the facilitator can then present its contents and show participants where they can find resources on those topics.
- **Conclusion:** The facilitator asks participants to add 1 keyword to the paperboard. This extra keyword should complete the "ideal profile" of the technical trainer with notions that came up during the activity.

4 Tips for facilitators

- **Scenarios can be adapted to the most common problems** you face in your local situation.
- **Encourage participants to be creative!** The funnier the play is, the more successful the activity will become. Facilitator's job is to make sure nevertheless that the play relevantly addresses the problematic elements of the scenario.
- **The facilitator should encourage free expression among participants:** there is often not a unique solution to the problematic situations depicted in the scenarios. There can however be a set of principles and procedures to be followed within a restoration worksite that can be recalled during the follow-up discussion. Even if the HERO toolboxes give, it can be reminded that the most important factor is that the technical workers should feel at ease with the tools and methodologies they implement.
- **The facilitator should make sure that no negative judgements are done** during the follow-up discussions and every remark should be made in a constructive spirit.
- **Problematics and solutions raised in the play and the follow-up discussion can initiate a broader reflection on how technical workers are brought to work with vulnerable trainees.** It's a great launchpad to test and implement new approaches as described in HERO's toolboxes.

5 Scenario ideas

- ① **Be on time!**
Bob is a new trainee on the restoration worksite. He is often late in the morning. His trainer has already given him a warning because he was late 3 days in a row last week. This morning, he showed up again 1 hour late. The trainer knows he lives quite far and has to take 2 different buses and walk over 20 min. Bob is quite serious in his work but needs to understand that this attitude will not be accepted in the professional world. How to talk to him?
 - **Roles:** Bob, the trainee / The trainer
 - **Problems to be discussed:**
 - Punctuality and professional world requirements
 - Team management and discipline
 - Taking into account trainees' individual problematics
- ② **Safety first!**
Alice started her training over 1 month ago but still shows some rebellious mind when it comes to wearing hard hats. Despite making her sign a contract where she commits to respect safety rules, her trainer often sees her without her hard hat. According to her, it's "too warm here to cover your head" and she doesn't like it. The trainer noticed some other trainees started to take off their hard hats as well. It is time for the trainer to make something about it.
 - **Roles:** Alice, the trainee / The trainer
 - **Problems to be discussed:**
 - Safety rules on the worksite
 - Team management and group dynamics

3 **Teamwork**

Nono has been on the construction site for 2 weeks and is being asked to take measurements on a wall. He is clearly having a lot of trouble using a measuring tape. Despite several explanations from his team leader, Nono still hasn't understood how to do it. Nunu, who has been on the site for 9 months, could be Nono's partner; however, Nunu does not seem very sociable nor willing to help Nono because he had a dispute with his previous partner. What should be done in these circumstances?

○ **Roles:** Nono and Nunu, the trainees / The trainer

○ **Problems to be discussed:**

- Difficulty with mathematics/spatial awareness
- Establishing a partnership
- Conflict prevention/synergy between team members

4 **The weight of the past**

Toto arrived from a foreign country a while ago and has a very complicated life story. This morning, it seems like he showed up on the worksite slightly intoxicated. And it's not the first time ... He has difficulty understanding why money is spent on restoring old monuments when people are starving in his country. He regularly monopolizes your time with his traumatic migration experience and seems to need someone to talk to. But it's a bit too much for you and you find it hard to stay in your role as a trainer/mentor. How can you best help him within the limits of your responsibilities?

○ **Roles:** Toto, the trainee / The trainer

○ **Problems to be discussed:**

- Addictive behaviours and safety issues
 - Attitude towards heritage
- Emotional protection / redirection to social workers

5 **The perfectionist**

Lilly is a new trainer and facilitator on your restoration worksite. She has extensive experience in prestigious historic sites and has been warmly recommended to you. Although she demonstrates real technical expertise, she is pretty rough and demanding with her team of trainees. Her level of expectation seems too high for her team of trainees with limited experience in restoration. She pushes them beyond a reasonable limit and it has negative impact over the whole team. You must have a discussion with her to handle this situation

○ **Roles:** Lilly, the trainer / The worksite manager

○ **Problems to be discussed:**

- Role and limits of a trainer
- Inclusiveness and group dynamic
- Consideration of trainees

2

Masonry

[See tutorial video on youtube](#)

1 Pedagogical Objectives

- Foundations of Masonry
- Mathematics and Geometry
- Reading Plans
- Handling Basic Tools and Materials

2 Technical Framework

 **Duration:** 13 hours (over 2 days)

 **Participants:** 3 individuals

 **Level:** Beginner / Intermediate

 **List of Materials for Each Participant:**

- Trowel and pointing trowel
- Spirit Level
- Rule
- Plumb Bob
- Square Pencil
- Sponge
- 86 Bricks
- ½ m² of Rubblestone
- 200L of Mortar
- Detailed Plan of the Model to Replicate

3 Step by step instructions

1 Step 1: Introduction to the Exercise and Verification of Basic Reading Plan Skills

- Present the plan and allow the trainee to become familiar with it without immediately providing all the explanations to encourage the trainee's reflection and their ability to project themselves into the activity.
- To assess the trainee's understanding, the instructor can ask questions about the greatest length of the wall (here, 200 cm). The instructor may inquire if the model contains bricks and where they are located. Additionally, the instructor can ask about lengths, widths, thicknesses, and heights. The instructor also points out the hidden edges of the plan (marked with dashed lines).
- Once the plan is well understood, the instructor can introduce the concept of the axis and the determination of the central point of the structure, which will be used in subsequent steps.

2 Step 2: Tracing Process

- Once the trainee has started to familiarize themselves with the plan, the instructor can **ask them to trace the longest length of the wall**. At this stage, the instructor can emphasize that this is the best way to reduce inaccuracies that may occur during tracing.
- **Use the square to mark the ends of the wall and note its thickness.**
- **The trainee can then determine the central point of the line drawn.**
- **Teach the trainee the Pythagorean theorem (3/4/5) as a more reliable method than using a square to draw the axis.**
- **Trace the axis.**
- **Draw the central wall in relation to the axis.**
- **Mark the locations of the brick pillars on the sides.**
- ⚠ **Attention: The instructor should remind the trainee that the lines should slightly extend beyond their length (10/20 cm) so that they remain visible when masonry begins to cover the marks. The trainee should then precisely indicate the segments on which they will be working.**

3 Step 3: Model Construction

- **Assembly of the corner chain** in bricks (the 3 pillars of the T-shaped structure)
- **Place alignment cords and explain their importance**, which is not always obvious to trainees (alignment of materials with respect to the layout).
- **Before laying the first course of rubblestones**, the trainee can **start by doing it without using mortar (dry laying)**, with 4 points of attention:
 - **Vary the size of the rubblestones** to facilitate the crossing of stones.
 - **Always place the rubblestones flat** on their largest face (lying or seated).
 - **Follow the alignment cords.**
 - **Start at the intersection of the walls**, which will help maintain cohesion between the two parts of the wall.
- Once the first course is prepared, the instructor comes to check the work. If dry laying is not correct, the instructor can **show the trainee the correct assembly of the rubblestones**, as this step is quite technical and important.
- When the layout is approved by the instructor, the trainee can then **start removing the stones** while keeping them in good order, so they can be put back with mortar.
- The trainee can start **laying the first course of rubblestones in the correct order and apply mortar**. The instructor can remind the trainee to always check the alignment of the stones with the alignment cords.
- Once the first course is completed, the trainee can **repeat the process for the upper courses in the end**. At this stage, the instructor can also explain that the crossing of stones is not only horizontal as in the first course but also vertical (see video).
- For the last course of rubblestones, the trainee should **not cover the stones with mortar to leave the stones exposed** while maintaining the flatness of the top (the level must be checked using a rule or a cord between the 2 pillars).
- When the structure is satisfactory, the trainee can start **applying mortar for joint finishing**.
- **Final step:** At the end of the session, the instructor conducts a **critical analysis of the work done with the trainees**, considering the perspective of the employer and the client to assess acquired skills and areas for improvement, as they might be required in a real professional setting.

Bricks detail, side view • Scale : 1/2

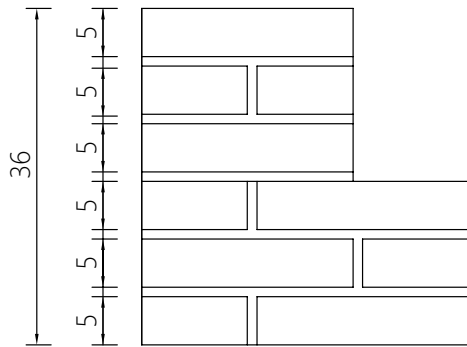

Top view • Scale : 1/15

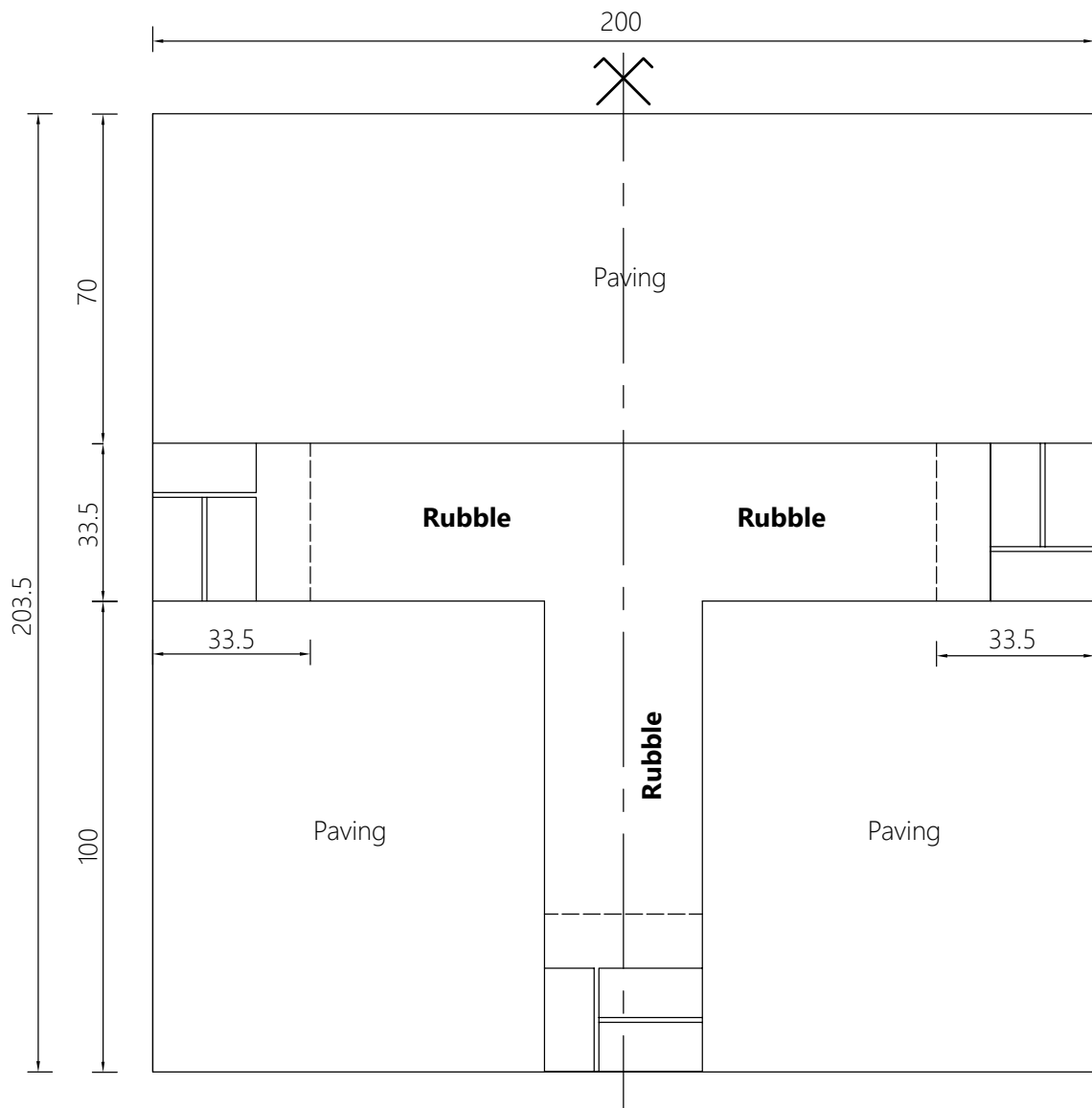

3 Paving

[See tutorial video on youtube](#)

1 Pedagogical Objectives

- Basics of Paving
- Mathematics and Geometry
- Creation of Patterns
- Handling Basic Tools and Materials

2 Technical Framework

 **Duration:** 13 hours (over 2 days)

 **Participants:** 1 person

 **Level:** Beginner / Intermediate

 **List of Materials for Each Participant:**

- Work surface: 3x3m
- Trowel and pointing trowel
- Spirit level
- Rule
- Mallet
- Square pencil
- 4m² of paving tiles (or equivalent materials)
- 280L of mortar
- 4 slats
- 4 rafters

3 Step by step instructions

1 Step 1: Layout
(approximately 30 minutes)

○ Ask the trainee to begin by drawing a square of 2m.

○ If necessary, remind or explain to the trainee the basic geometric rules of a square (4 sides of equal length and 4 right angles), and the Pythagorean theorem (3/4/5).

○ Verification by the instructor:

- Draw the two diagonals of the square.
- Measure from the center of the diagonals to the angles: the half-diagonals should all be the same length (here, the measurement should be 141.5cm).
- If the measurement is incorrect, adjust the layout accordingly.

2 Step 2: Framework setup
(approximately 45 minutes)

○ The trainee will position the 4 rafters around the square. To facilitate this step, the trainee can use rafters whose length will exceed on each side.

○ Level the frame (horizontal alignment). Since the work surface may not be level, the frame level must be checked and adjusted accordingly. If the surface is not level, the frame level will be determined from the highest point.

3 Step 3: Creation of the opus (approximately 3 hours)

- **The instructor begins by explaining to the trainee the orientation of the pattern,** which should face the virtual door of the room. After that, the trainee determines the virtual location of the door.
- **The trainee is instructed to create a free pattern with the available materials for a personalized paving.** The instructor explains that a craftsman or a worker can make aesthetic suggestions to the client.
- **At this stage, the trainee will start by testing their idea by laying a first version of the pattern without mortar.**
The instructor puts them in a situation to present their pattern to the client.
- **The instructor highlights the positive aspects of the pattern** and, if necessary, corrects inconsistencies while preserving the trainee's creative spirit.
- **Once approved, the pattern is photographed to serve as a reference for the final creation with mortar.**

4 Step 4: Paving installation (approximately 8 hours)

- **The trainee disassembles their dry paving,** storing a portion in water to have the material ready for implementation.
- **The trainee spreads a layer of dry and lean mortar** (1 part lime / 5 parts sand) using a rule that must always be in contact at its two ends on the rafters of the frame. This layer starts at the virtual back of the room (opposite the location of the virtual door) and extends over a length of approximately 40cm, corresponding to the practical working distance without having to walk on the mortar.
- **Repeat the same step on the corners** on each side of the door to later lay the corner bricks.
- **Sprinkle the lime sand. In the case of dry mortar:** moisten the lime by lightly watering it to create a rain effect and allow the wet bricks to adhere to the dry mortar
- **Lay the paving elements at the 4 corners following the pattern in the photo:**
 - The trainee places the 1st corner level. This element must be tapped with a mallet until it penetrates stably into the mortar.
 - The next 3 corners are laid level relative to the 1st corner. Again, all 3 corners are tapped during adjustment.

○ Lay the paving starting from the back of the surface, connecting the 2 corners.

- For each paving element, check the joint spacing using a rule resting on each of its ends on the 2 corners.
- If the placed element does not touch the rule, it has been tapped too much. It will need to be lifted until it touches the rule.
- If the rule does not touch one of the two ends, the placed element is too high and needs to be tapped more.
- Repeat this step until the band is completed.
- At the end of laying the band, check the alignment of the paving joints using a rule or a cord.

○ Lay the 2nd band:

- Place the 2 reference paving elements at the 2 ends adjusted relative to the corner elements already adjusted.
- The trainee continues to lay the paving elements as described earlier until completing a new row.

○ Repeat the previous steps of the 40cm mortar band and paving row until the work surface is complete.

⚠ Attention, regularly check:

- The regularity of joints (thickness and alignment).
- With the help of a rule placed diagonally, check if the surface is not uneven (warped).

○ Finishing Joints: Here is one of the possible techniques

- The mortar used for jointing is dry mortar. The commonly used ratio is 1 volume of binder to 3 volumes of sand (particle size 0/2 mm to 0/4). Spread the dry mortar over the entire paving using a fine broom, allowing the mortar to enter the joints and leaving the tiles clean without mortar traces.
- Project the dry mortar as rain by moistening it with water (dispensing hose, watering can, projection with a broom). As it becomes moist, the mortar will penetrate the joints. As the level of the joints descends, after drying the support, spread the joint again using a broom.
- Repeat these steps until the mortar, once wet, no longer descends.
- Once the paving is dry, proceed with a light cleaning to remove residual grains.

Top view

Scale : 1/15

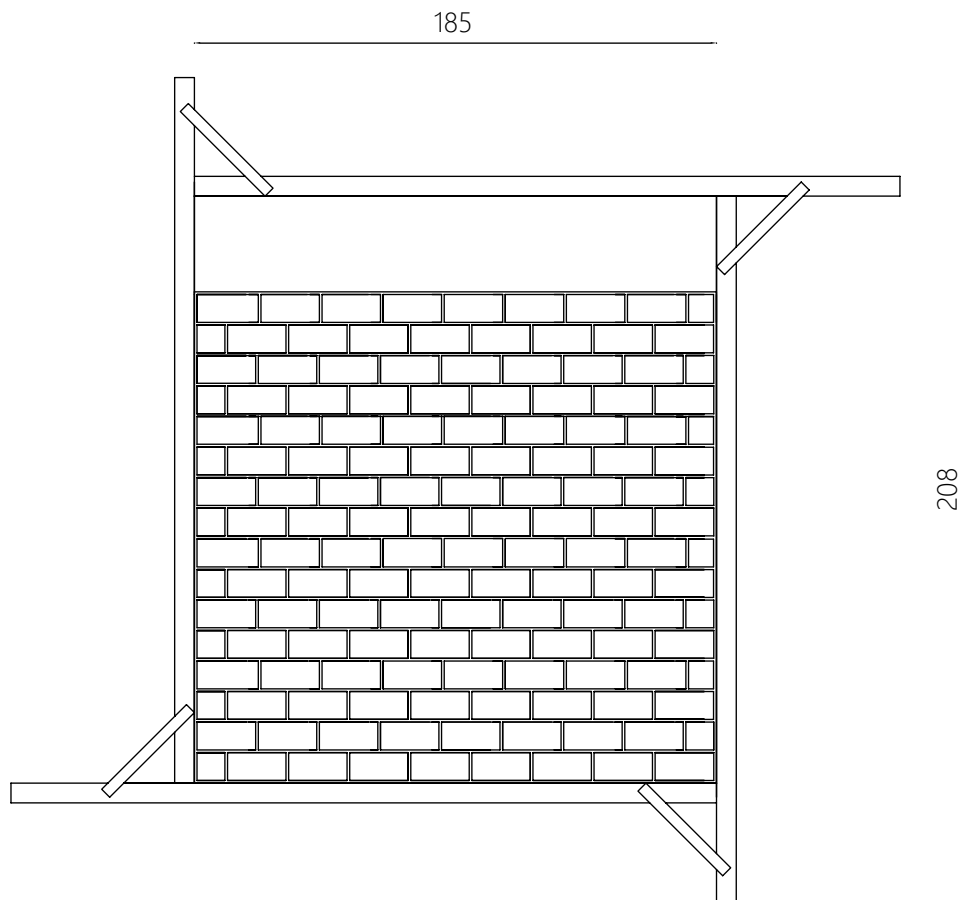

4

Coating

[See tutorial video on youtube](#)

1 Pedagogical Objectives

- Learning the technique of plaster projection
- Mixing plaster in the correct proportions
- Step-by-step handling of plasters
- Calculation of surfaces, volumes, and proportions (mathematics)

2 Technical Framework

 **Duration:** 13 hours per person over 2 days

 **Surface:** 4 m² per person

 **Level:** Beginner

 **List of Materials for Each Participant:**

- Wheelbarrow
- Shovel
- 2 graduated buckets
- Trowel
- Wooden float
- Aluminum rule
- 4 ceramic tiles (terracotta, etc.)
- Broom
- Plumb line
- 2m rule
- 100L of 0.4cm sand
- 35kg of hydraulic lime NHL 3.5
- 20kg of aerial lime CL 80
- 60L of 0.2cm sand
- Water for the mixture

3 Step by step instructions

1 Step 1: Wall humidification

- Spray water using a broom or a dispersing water jet.
- Start from the top of the wall and work your way down until the wall no longer absorbs water.

2 Step 2: Gobetis Preparation (Bonding Layer)

- **Mixing:** Combine 2 volumes of sand with 1 volume of hydraulic lime NHL 3.5. If the surface is too smooth, use a 1:1 ratio of sand to lime. Note that for concrete surfaces, it's advisable to replace lime with a 50/50 mix of lime and cement.
- Once the mixture is dry (approximately 2 hours), add water to achieve a soupy consistency.
- **Projection:** The trainee will perform the plastering motion similar to a tennis backhand. The precise motion is demonstrated in the video.
- **Note:** The gobetis layer should be very thin (1 or 2 mm) and rough. The thinness allows the gobetis to dry quickly, and the roughness provides better adhesion in the subsequent steps.
- **Allow it to dry for a minimum of 1 hour and 30 minutes.** During this drying time, the instructor may ask the trainee to calculate the perimeter, surface area, and volume. The trainee can then calculate the proportions of lime and sand in the mortars to estimate the quantities needed for the next steps. This step also introduces unit conversion.

3 Step 3: Rough rendering

- **Mixing:** Mix 3 volumes of 0.4 sand with 1 volume of hydraulic lime NHL 3.5. Add water to achieve a fluid paste.
- **Guide Installation:**
 - Take a tile, apply adhesive to one side, and position it on one of the top corners of the area to be rendered, pressing it until it reaches a thickness of 2cm. This tile serves as a reference for plumb and alignment.
 - Take a second tile, place it in the bottom corner below the first tile, and adjust its depth relative to the first tile using a plumb line.
 - Repeat these steps for tiles 3 and 4 in the opposite corners, adjusting tile 4 relative to tile 3. Tile 3 is placed 1.8m from tile 1.
 - Fill a vertical strip of mortar between tiles 1 and 2, then another strip between tiles 3 and 4. These strips are leveled with a rule that must always be in contact with the tiles.
 - Let it dry for about 1 hour.
- **Application of Rough Rendering:**
 - Project the rough rendering by forming lines so that they can slightly overlap in a scale-like pattern.
 - Before the rough rendering becomes too firm, according to local conditions (humidity, wind, sun, etc.), level it with a rule by lifting it with a shear and scraping motion upwards. The rule must always be in contact with the tiles previously placed.
 - Repeat this step until the rough rendering is applied over the entire surface from top to bottom. Note: After leveling with the rule, if there are hollows, it's better to wait for the first layer of rough rendering to dry a bit before filling these hollows. Filling these hollows too quickly and with too much thickness could cause the rough rendering to detach.

4 Step 4: Finishing

- **Note:** On a typical construction site, there is usually a 48-hour wait between the rough rendering and finishing. In this training setting, the drying time is reduced to overnight between day 1 and day 2, which should be sufficient for the finishing.
- If there is waiting time, the instructor can initiate a discussion around the theoretical aspects of the plaster (origin, use, manufacturing, advantages, etc.), or revisit the mathematical aspects covered in step 1. The instructor can also present different types of finishing.
- **Preparation of finishing mortar:** mix 4 volumes of 0.2 sand with 1 volume of aerial lime CL, and add water to obtain a fluid paste.
- **Application of Finishing Mortar:**
 - Fill the edge of the float directed towards the wall with finishing mortar.
 - Hold the float firmly with both hands starting from the bottom of the surface. Note: The instructor must demonstrate the posture with bent knees and a straight back, then pushing with the legs on the ascent.
 - During application, the trainee should exert firm and constant pressure on the float, moving from the bottom to the top (can combine with a small horizontal sawing effect). The trainee applies the mortar this way.
- Repeat this step until covering the surface up to human height. Use the edge of the float to remove excess finishing mortar (can also be done with a rule).
- If the float sticks to the already applied finishing mortar, it is not dry enough, and the trainee should wait. The trainee can continue to fill the remaining surface.
- When the finishing mortar no longer sticks to the float, take the float and, with circular movements, firm pressure, and a lively motion (see video), trowel the finishing mortar. The surface and color texture should be uniform. If needed, the direction of circular movements can be crossed in the shape of an "8".

5 Cobbled Stone Paving

[See tutorial video on youtube](#)

1 Pedagogical Objectives

- Foundations of Masonry
- Mathematics and Geometry
- Basics of Paving
- Basics of stone carving
- Handling Basic Tools and Materials

2 Technical Framework

 **Duration:** 16h (over 2 days)

 **Participants:** 1 person

 **Level:** Beginner / Intermediate

 **List of Materials for Each Participant:**

- Work surface: 1,5x0,75m
- Measuring tape
- 4 pegs
- Nails
- Builders line
- 2 rafters 2m long with 2 half lap joints (1.5m between the joints)
- 2 rafters 1,2m long with 2 half lap joints (0.75m between the joints)
- 4 stakes
- Hoe
- Shovel
- Spirit level
- 5m² of paving stones
- Mallet
- Hammer
- Chisel
- Broom

3 Step by step instructions

① **Step 1: Ground preparation**
(approximately 60 minutes)

○ Ask the trainee to begin by drawing a rectangle of 1,5m x 0,75m.

○ If necessary, remind or explain to the trainee the basic geometric rules of a rectangle (2 pairs of facing sides with equal length and 4 right angles), and the Pythagorean theorem (3/4/5).

○ Mark the area with the pegs and the builders line or using marble dust.

○ Dig the marked area and remove 15-20 cm of soil

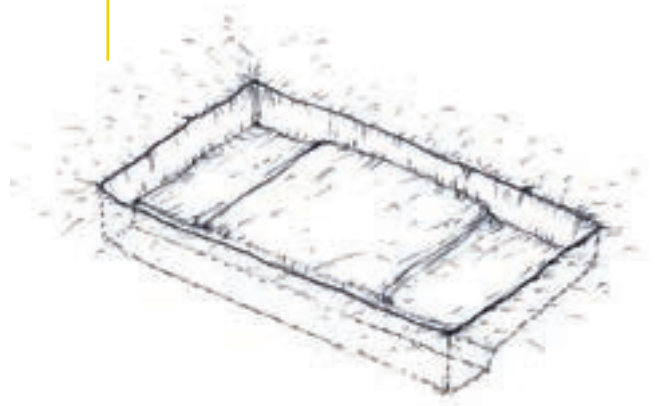

2 Step 2: Formwork installation
(approximately 60 minutes)

- The trainee will position the 4 rafters around the rectangle making the construction frame. To facilitate this step, the trainee has to make 4 half lap joints in the corners of the frame and reinforce each of them with a dowel pin.
- Level the frame with the minimum slope (horizontal alignment). Since the work surface may not be level, the frame level must be checked and adjusted accordingly.

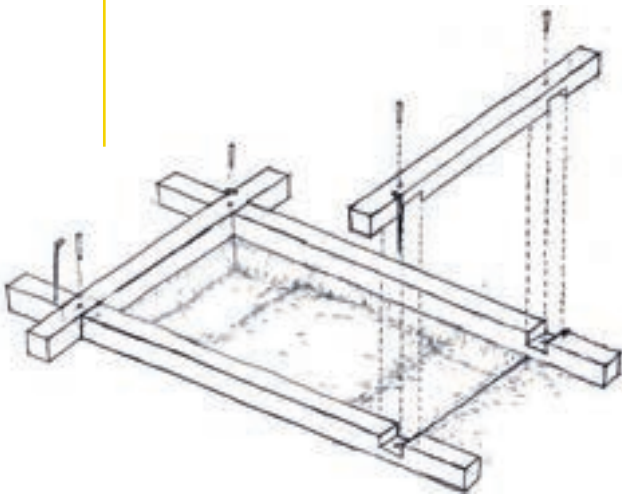

3 Step 3: Lay the outline stones
(approximately 4 hours)

- The instructor begins by explaining to the trainee the laying pattern (flat parallel) and makes a demonstration of laying the first couple of stones.
- Spread a layer of dry soil or lime sand before laying the stone.
- Lay the stones at the outline of the construction following the pattern in the instructions:
 - The trainee places the 1st line (kerb) of stones. The stones must be tapped with a mallet until they penetrate stably into the soil. The first line of stones (kerb) has to protrude from the formwork by 2-3 cm and the height of the stones of the outlines must be at least 30cm.
 - The corners stones (endings and reference elements) of the next lines of the construction are laid level relative to the formwork. Again, all stones are tapped during adjustment.
- Place every stone 2 cm higher of the final level and then tap the stone repeatedly with a mallet or a wood stick until the stone reach the correct level of the construction.
- Select the more suitable stone for each position and break/carve the last stone of the line if it is necessary.

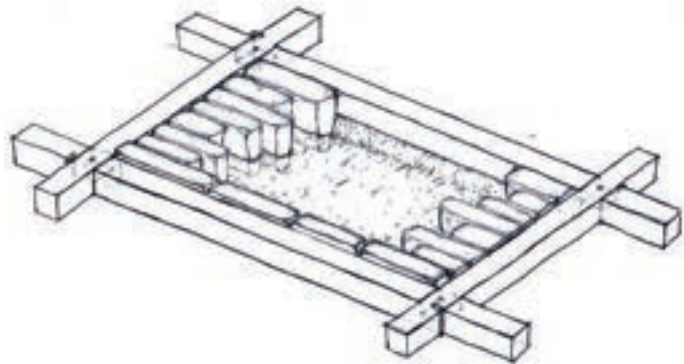

4 Step 4: Lay the rest of the paving area (approximately 7 hours)

- Lay the rest of the paving area with stones following the above rules:
 - Lay the paving starting from the first row next to the kerb, connecting the 2 corners.
 - For each stone, check the joint spacing using a rule resting on each of its ends on the 2 corners.
 - If the placed stone does not touch the rule, it has been tapped too much. It will need to be lifted until it touches the rule.
 - If the rule does not touch one of the two ends, the placed element is too high and needs to be tapped more.
 - The trainee continues to lay the stones as described earlier until completing the rest of the rows.
- ⚠ **Attention, regularly check:**
 - The regularity of joints (thickness and alignment).
 - With the help of a rule placed diagonally, check if the surface is not uneven (warped).

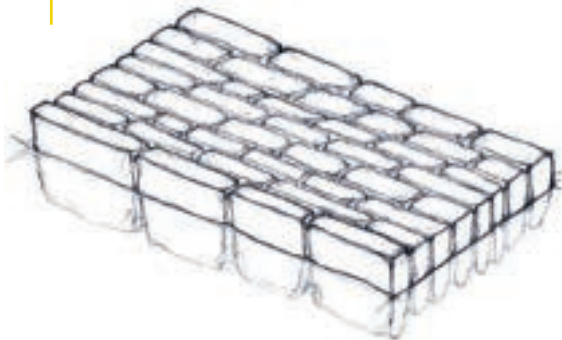

5 Step 5: Finishing Joints (3 hours)

- **Finishing Joints:**
 - The material used for jointing is dry mixture of soil and sand. The commonly used ratio is 1 volume of soil to 1 volume of sand (particle size 0/2 mm to 0/4). Spread the dry material over the entire paving using a fine broom, allowing the mixture to enter the joints and leaving the stones clean.
 - Project the dry mixture as rain by moistening it with water (dispensing hose, watering can, projection with a broom). As it becomes moist, the mixture will penetrate the joints. As the level of the joints descends, after drying the support, spread the joint again using a broom.
 - Repeat these steps until the mixture, once wet, no longer descends.
 - Once the paving is dry, proceed with a light cleaning to remove residual grains.

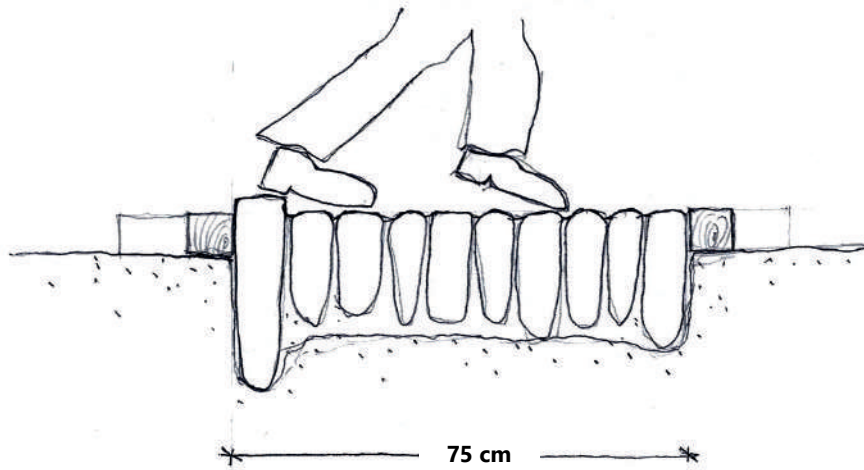

Section

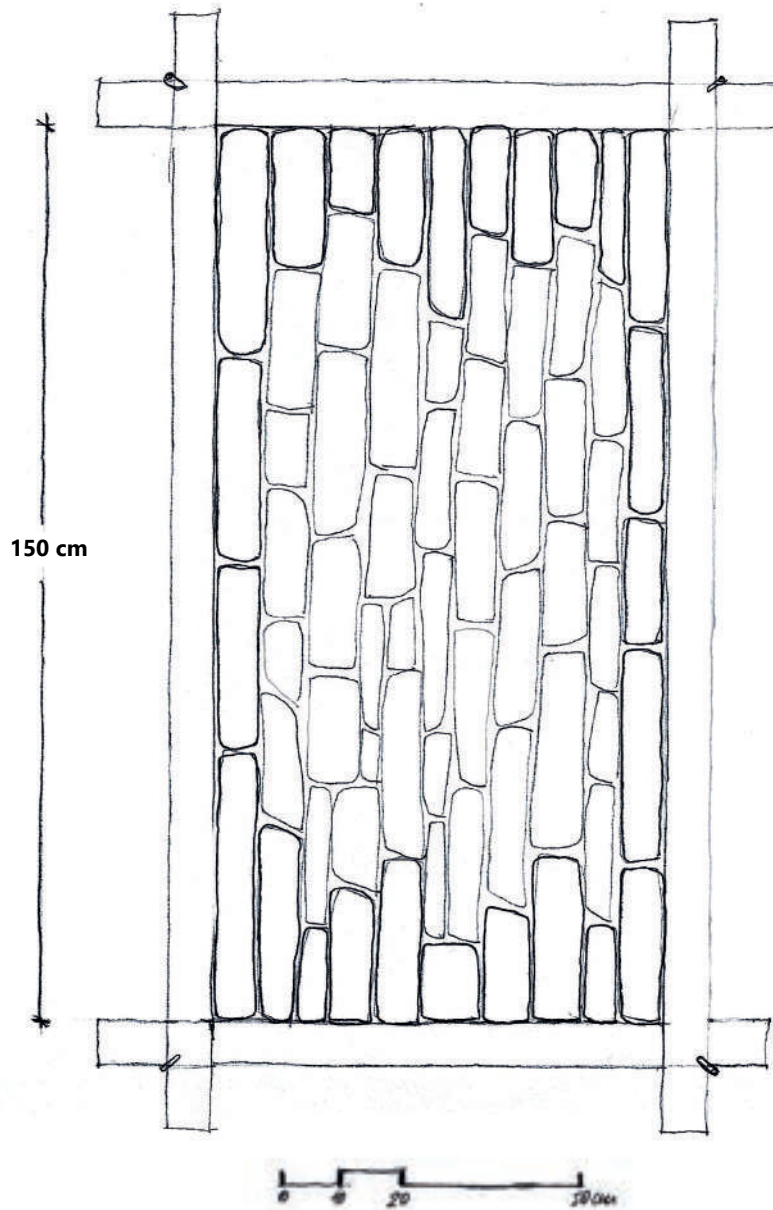

Plan

6

Masonry repointing

[See tutorial video on youtube](#) ▶

1 Pedagogical Objectives

- Learning the technique of repointing masonry
- Mixing mortar in the correct proportions
- Step-by-step handling of repointing mortar

2 Technical Framework

 **Duration:** 10 hours per person over 2 days

 **Surface:** 1 m² per person

 **Level:** Beginner

 **List of Materials for Each Participant:**

- Hammer
- Mortar raking chisel
- Pointbrush
- Wheelbarrow
- Shovel
- Sand sieve
- 2 graduated buckets
- Trowel
- Pointing trowel
- Hawk board
- Wooden mallet
- Wooden seam
- Hessian sheet
- 15kg of Lime putty
- 45L of 0.2 cm sand
- Water for the mixture

3 Step by step instructions

- 1 **Step 1: Mortar removal** (3 hours)
 - **Rake off the deteriorated mortar joints** using a hammer and touching chisel.
 - **Clean the joints from the dust and grouting** remains with a jointbrush.
 - **Apply water** using a broom or a dispersing water jet.
 - **Start from the top of the surface and work your way down** until the stone masonry is clean and no longer absorbs water.
 - **Note:** The trainee makes a demonstration of the mortar removal and the use of tools.

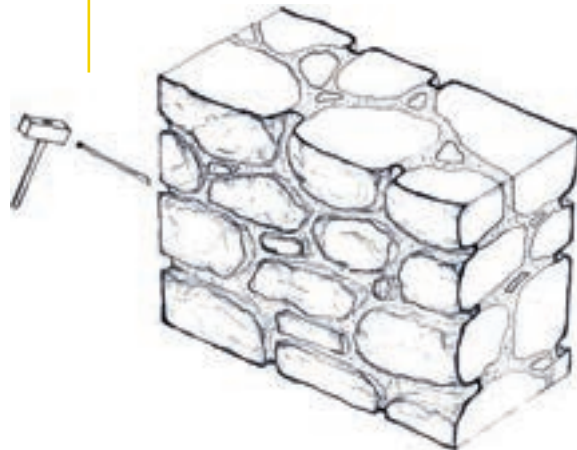

2 Step 2: Mortar preparation (1 hour)

- **Prepare and measure your raw materials.** A ratio of three parts sand to one part lime is generally used. Don't be tempted to measure by shovelfuls – instead, use smaller gauging boxes.
- **Place all ingredients in a tub or mixing box and after that thoroughly mix all the ingredients.** You have to sift the sand in order to be sure that you have the proper particle size. There are two ways to mix your lime mortar – by hand or using a cement mixer. Working by hand is the traditional method and gives you greater control over the finished result.
- **Mix the mortar** until it will hold shape when formed into a solid ball; there should be no flow or spread of the mortar at this stage.
- **Let the mix hydrate** for a one to two hours.
- **Note:** If the mix becomes dry, add some water to make it workable, but still relatively stiff, which results in good workability and minimum smearing.



3 Step 3: Mortar application (4 hours)

- **Place some mortar on your Hawk Board and make the mix workable, but still relatively stiff.**
- **Place the mortar into the joints with the pointing trowel.** Depending upon the depth of the joint that has been raked out, several lifts of mortar may need to be applied to bring the new joint even with the surface of the wall. Placing the mortar in lifts helps fill any voids and minimizes shrinkage of the new mortar. Avoid air pockets and voids by pressing or forcing the layers of mortar into the joint in one direction only. Right-handed bricklayers usually point from right-to-left. The layers should always be pushed back upon the previous layer underneath. This will force out air pockets and leave no voids. Head joints can be completely filled if the mortar is worked from the bottom of the joint up, pressing mortar back on top of itself by striking the joints in a downward motion.
- **Note:** Before the pointing mortar is forced into the raked out joints, the joints should be moistened with a hose and sprinkling nozzle, or with a brush and bucket of water. The water that is applied should be allowed to absorb into the masonry units before placing mortar into the joints.

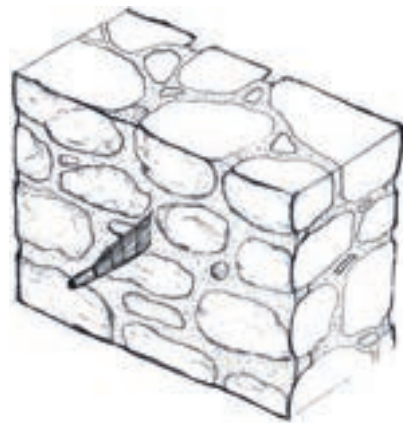

4 **Step 4: Lay the rest of the paving area**
(approximately 7 hours)

- **Brush or wipe the work** after the mortar has set up enough to prevent smearing.
- **Scrap the stones with the trowel** to remove any excess mortar.
- **Remove the air and compress the mortar** using the mallet and the wooden seam when the mortar is completely dry.
- **Note:** Depending on the season and the climate of your wall, you have to secure that your work will not dry too fast. Place and wet a hessian to create a moist environment in front of your wall for some days.



Section

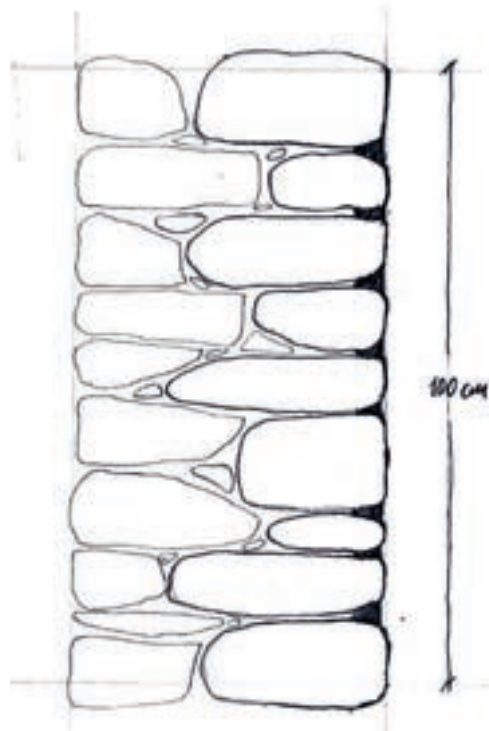

Elevation

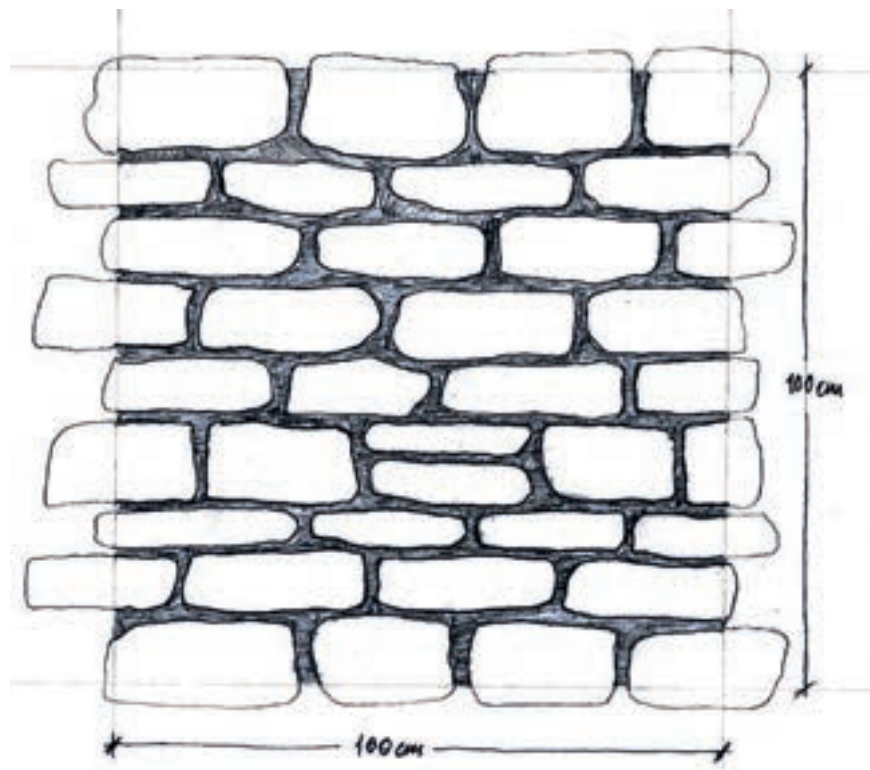

7

Restoring dry stone retaining, single and double stack walls

[See tutorial video on youtube](#)

1 Pedagogical Objectives

- **Clear Instruction:** Explain construction principles clearly at the start and reinforce them throughout.
- **Engagement:** Keep participants engaged through effective communication and demonstration.
- **Safety:** Prioritize safety with proper tool use and emergency preparedness.
- **Organization:** Manage logistics and tasks efficiently to meet workshop goals.
- **Adaptability:** Adjust teaching methods to suit participants' needs and resolve conflicts diplomatically.
- **Heritage Awareness:** Foster appreciation for local dry stone heritage and environmental impact.

2 Technical Framework

 **Duration:** Usually lasts for 2 to 3 days

 **Participants:** a leader can handle 5 to 7 participants

 **Level:** Beginner

 **List of Materials:**

- Stones
- Basic tools and equipment such as gloves, bucket for smaller stones, hammer

3 Step by step instructions

1 Step 1: Gathering and Initial Contact with Participants

○ Arrival at The Workshop Location

Leaders and participants arrive at the gathering place about an hour before the official start to:

- Survey the site, prepare tools, gloves, and other materials for the workshop
 - Agree among themselves who is responsible for what and ensure everyone is clear on their tasks
 - Take photographs of the site before the workshop begins - it's always good to have before/after photos
 - Welcome the master builders who usually arrive early and coordinate the plan with them
 - Greet participants as they begin to arrive just before the start
- Aside from logistics, this is a good opportunity for informal introductions, socializing, and building atmosphere before the workshop.

○ Beginning and Arrival of Participants: introduction and getting to know each other

The formal start of the workshop takes place at the gathering point. This is dedicated to introductions and getting to know each other. Someone takes the floor (usually the organizer first) and speaks so everyone can hear.

- **Introductions:** Organizers and leaders give a welcoming and introductory speech to the participants, briefly introducing themselves, their organizations, and their roles in the workshop. Introduce the master builders - local builders, giving them space to briefly introduce themselves.
- **Participant introductions:** Give participants a chance to introduce themselves, share a few words about their experience with dry stone walls, and if they have any prior building experience.
- **Introducing the location and heading to the site:** Leaders provide the basic context of the location, the function, and the origin of the wall to be worked on (e.g., pasture, boundary, vineyard terrace...), as well as a clear projection of the workshop's goal and purpose.

- Example: "The small wall along the village path where we will be working used to serve as a vineyard fence. Today, it's an overgrown olive grove, and we are restoring it to enhance the surroundings and create a biking trail passing through. If we have time, we will also build a small dry stone bench in the shade for resting."
- **Presentation on dry stone heritage**
 - The leader arranges with the organizer whether to: a) Organize a lecture on dry stone heritage before the workshop itself (the evening before, the morning before, during a long siesta break in case of longer workshops...), or b) Provide a 10-15 minute talk about dry stone walls in the context of the location at the work site. The second option (b) is the minimum required in terms of theoretical knowledge transfer.
 - The presentation provides a broader picture of dry stone walls and supports practical work. Participants better understand what and why they are doing, and the work is not just "breaking stones" by the road. In the presentation, it's desirable to cover the phenomenon of dry stone heritage in general, as well as the specific context of the current workshop (e.g., at a workshop in Konavle, dedicate part of the lecture to local dry stone walls and perhaps previous workshops held in that area).
- **Introduction to building**

The introduction to building takes place directly at the construction site - leaders take the floor and address everyone.

 - **Basic building rules:** Briefly explain the basic rules and common mistakes, not too extensively to avoid overwhelming participants, and keep in mind that these rules should be reiterated throughout the workshop.
 - **Handling stone - simplicity, efficiency:** Feel how the stone sits in the hand. Adjust handling the stone to one's abilities, preferences, and strength. Train the eye to spot suitable stones. Minimize moving and lifting the same stone twice to conserve energy. Don't throw the stone back on the ground.
 - **Demonstration - show the rules:** Demonstrate on an example - an existing wall and a small demonstration area with a few stones.
 - **Protective gear:** Hat or cap for sun protection, adequate water supply, gloves, and sturdy shoes. When chiseling stone, wear safety glasses to protect from flying fragments.
- **Tools:** From the most essential to the more advanced. Explain how they are used: axe, saw, pruning shears, sickle for clearing vegetation, wheelbarrow, measuring tape, bucket, straps or slings for transporting small and large stones, shovel, pickaxe, crowbar for digging and shaping stones, sledgehammer, mason's hammer, mallet, wedges, chisel for shaping stones.
- **Safety instructions and common injuries:** Finger injuries, ankle injuries, flying fragments from chiseling.
- **First aid instructions:** Leaders must have knowledge and provide a basic first aid kit on site.
- **Lifting stones:** It's crucial to know the proper way to lift heavier stones. Lift using leg power from a deadlift position, not from bending over. Maintain stability and safety in every movement. Seek help from others and develop mutual trust in handling heavier stones.
- **Warm-up:** Before starting construction, try to foresee lighter activities for warming up, e.g., walking to the work site, clearing vegetation, collecting smaller stones. Where possible, especially for multi-day workshops, organize a short physical exercise session before the workshop, stretching, etc.

2 Step 2: From the Start of Construction Onward: Working with Stone and People, Additional Instructions, Corrections, Emergency Situations

○ Organisation of work

- **All building rules are applied**, with particular attention to linking theoretical rules with practice.
- **Controlled demolition of wall sections for repairs:** The general rule is "if it hasn't fallen, don't touch it," but if the wall's stability is compromised, the "unhealthy" part should be removed.
- **During demolition and sorting of stones, some stones will inevitably end up on the ground temporarily.** It is important to leave a minimal corridor next to the wall for maneuvering space during construction.
- **Do not immediately demolish all "unhealthy" parts of the wall;** stones from the top of an unhealthy wall can be immediately incorporated into the segment being built next to it, thus conserving energy. The same applies to rubble.
- **Control the handling of very large stones** - techniques for lifting, moving, and extracting. The safety of participants and leaders is a priority.
- **If building a new wall from the foundation, and elsewhere when needed due to complexity, use a rope for precision in the alignment of the wall face.**

○ Supervision and support

- **Monitoring progress:** Continuously check the progress of the participants, offering advice, corrections, and encouragement. This ensures that everyone is on the same page and mistakes are caught early.
- **Hands-on demonstrations:** Regularly demonstrate techniques to ensure participants understand the proper methods.
- **Group dynamics:** Foster a positive and collaborative environment, encouraging teamwork and mutual support among participants.
- **Problem-solving:** Address any issues or conflicts promptly and diplomatically to maintain a smooth workflow.

○ Acquired techniques and knowledge

- **Stone selection and handling:** Participants should learn how to select appropriate stones and handle them efficiently.
- **Building techniques:** Participants should become proficient in basic dry stone walling techniques, including foundation laying, stone fitting, and maintaining wall stability.
- **Tool usage:** Understanding the proper use of various tools involved in dry stone walling.
- **Safety practices:** Emphasis on safety, including proper lifting techniques and the use of protective gear.

○ Emergencies

- **Medical emergencies:** Leaders must be trained in first aid and have a basic first aid kit on-site. Know the local emergency contact numbers and nearest medical facilities.
- **Structural failures:** In the event of a structural failure, evacuate the area immediately, assess the damage, and determine the cause before continuing work.
- **Weather conditions:** Monitor weather forecasts and be prepared to halt work in case of extreme weather conditions to ensure participant safety.
- **Accidents:** Have a clear plan in place for responding to accidents, including procedures for seeking medical help and documenting the incident for future reference.

3 Step 3: Learning Outcomes and Specifications for an Educational Dry Stone Wall Workshop

OUTCOME (the participant knows)	SPECIFICATION
Basic techniques	Done at all workshops
Basic theoretical knowledge of dry stone wall heritage and construction techniques	Theoretical part, lecture, discussion, questions and answers
To prepare the base for the foundation	Clear the vegetation from the surface where the wall will be built. Excavate and level the top layer of soil. If necessary, add small stones to the foundation base and compact them well into the ground.
To select and place the foundation stones	Lay large flat stones on the foundation with small gaps between them in two parallel rows. Fill the space between the rows of foundation stones with smaller and medium-sized stones.
To build and fill with small stones	Build the wall from the outside towards the inside. Start with the outer walls being constructed simultaneously. Fill the space between the outer walls with smaller and medium-sized stones. Securely embed the stones and, if necessary, support them with smaller stones from the rear. Position each stone so that it covers the joint of two stones in the bottom row. Place the stone with its longer side facing inward. Ensure that each stone has a flat top surface, sloping inward or diagonally. Construct the wall while ensuring that the outer walls remain parallel. The number of rows depends on the desired height of the wall.
Advanced techniques	Done at specific workshops
To dress the stone	Using basic tools, shape the stone to fit its intended place in the wall.
To set through stones	Lay the through stones across the length of the wall. They should be long enough so that their side faces are visible on both sides of the wall.
To set the coping stones	Use as rectangular stones as possible, with at least two flat surfaces. Use stones of equal height on both faces and alternate the direction of the longer axis of coping stones from course to course. Dress the stones as needed, and if possible, completely avoid supporting them with smaller stones.
To set the capstones	Construct the wall's coping in the local style. A more durable and sturdy wall is achieved by using larger stones, whether they are laid horizontally, diagonally, or vertically, including longer stones that may form projections (such as copings, courses, ledges, etc.).
Prepare the foundation base.	Clear the vegetation from the surface where the wall will be built. Excavate and level the top layer of soil. If necessary, fill the foundation base with small stones and compact them well into the soil.

4 **Some common mistakes of leaders include:**

- **Insufficiently explaining all construction principles** at the beginning.
- **Forgetting to reiterate basic construction principles** as the workshop progresses (on the second or third day).
- **Repeating rules without clear explanations** on how to apply them to the already built wall.
- **Correcting mistakes in the wall themselves** without involving participants.
- **Focusing too much on construction** and too little on engaging participants.
- **Not speaking aloud enough and not announcing construction phases** (too many comments in a row can lead to overload).
- **Not sorting stones**, leaving poor-quality stones for the end.
- **Allowing participants to filter themselves**, meaning they mainly work with the highly motivated ones while leaving quieter participants on the sidelines.

By following these guidelines, the workshop will run smoothly, ensuring participants gain valuable skills and knowledge while maintaining a safe and enjoyable environment.

Single stack wall restoration

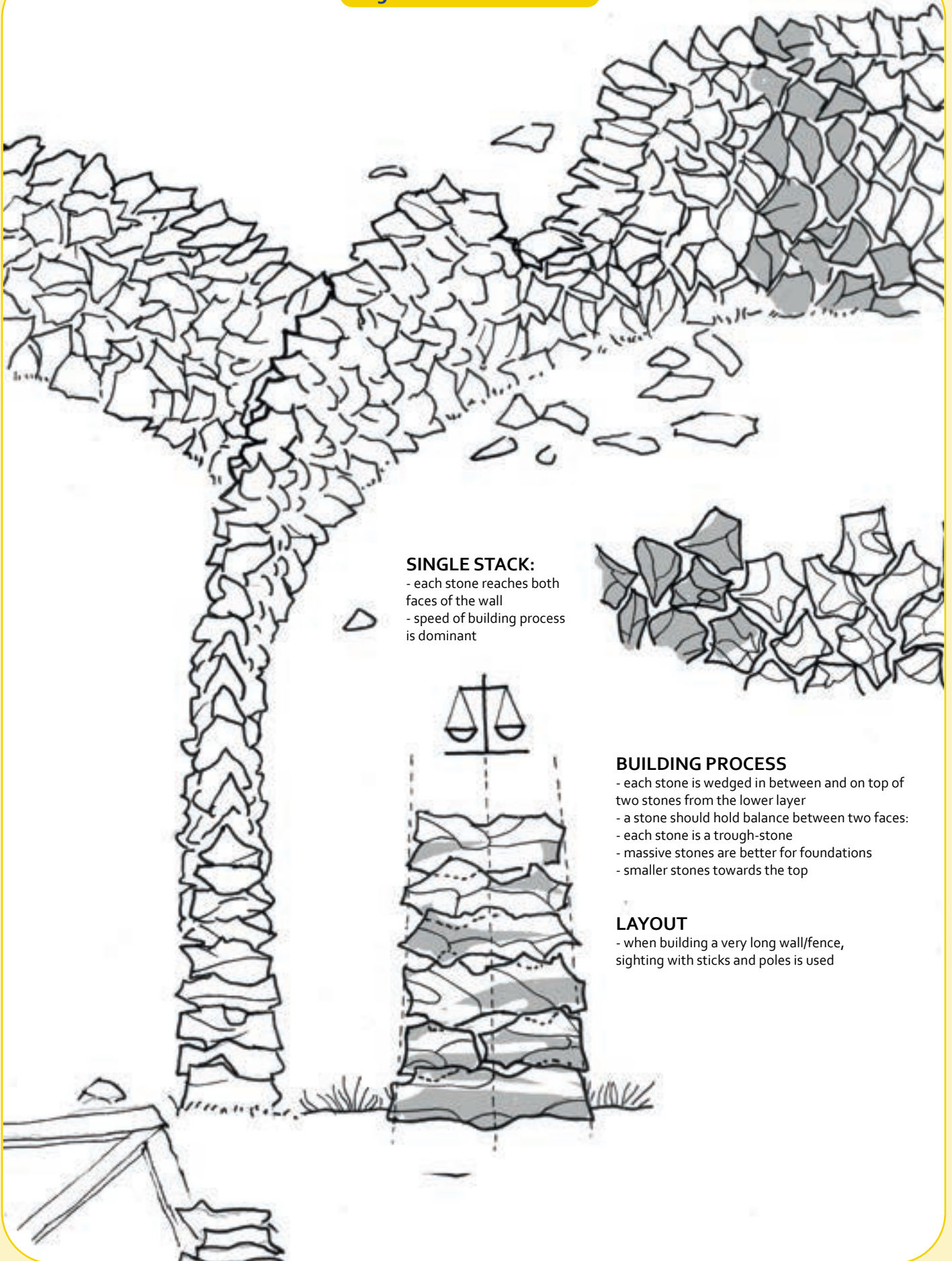

SINGLE STACK:
 - each stone reaches both faces of the wall
 - speed of building process is dominant

BUILDING PROCESS

- each stone is wedged in between and on top of two stones from the lower layer
- a stone should hold balance between two faces:
- each stone is a trough-stone
- massive stones are better for foundations
- smaller stones towards the top

LAYOUT

- when building a very long wall/fence, sighting with sticks and poles is used

Double stack wall restoration

BUILDING CORNERS

- save the best, most regular stones for the corners, (also the most skilled builders)
- if necessary, shape the stones with a hammer
- overlap cornerstones of adjoining faces in a comb-like manner as much as possible

STEP 6: NEXT LAYER + FILL (REPEAT)

- **A STONE SHOULD ALWAYS COVER TWO STONES!**
- all of the rules for building and filling first layer are also applicable on upward layers, but each stone should always be placed on top of a crack, to connect the stones below it.
- use anchor trough-stones sparingly, at strategic positions
- each layer should be a bit narrower, but not too much!
- build and fill on the inside before moving on to the next layer!
- remember to take a step back and sight the whole face of the wall

STEP 4: GROUND LAYER - BOTH SIDES

- both sides of the wall should be built at the same rate.
- **TOP SURFACE OF EACH STONE MUST NOT BE LEANING OUTWARDS!**
- we place stones "the longer side in", perpendicular to the face of the wall, for better anchoring and stability.

STEP 3: WALL FACE LAYOUT

- using keystones to lay out a building line
- "sighting" of the wall face is necessary at all times during the building process:
- regular face of the wall makes the best effect!
- if possible, chalking a layout on the ground can be helpful
- using a wood cane or metal rod A-shaped construction (batter frame) with straight rope when possible is preferred and more professional, but often gets in the way when working with many participants and not always applicable (curved walls).

STEP 1: CLEANING

- remove collapsed stones:
- clear the collapsed part of the wall, reach flat, firm ground or static "healthy" part of the wall.
- **TAKE EXTRA TIME TO DIG OUT ANY CROOKED OR LEANING ROCKS!**

STEP 7: FINAL LAYER

- if available, we save flat and thin stones for the top layer. top layer stones should be neither too massive or too tiny.

SORTING

- massive stones are used in foundations
- thinner, flat slates are saved for the top as they might break lower in the wall
- longitudinal trough-stones serve as anchors and are used sparingly as there usually aren't many available. ideally they connect both faces of the wall
- small and round stones of different sizes are used as filling stones (škalja)
- everything else is used to build faces of the wall

SHAPING STONES

- roughly shape stones with a hammer - if you must!
- few cuts should be enough
- usually we cut off the extra on top or on the side
- rarely we chisel the face to be flat
- a stone is never shaped while already placed into the wall as the vibrations might destabilize the surrounding stones

STEP 5: FILL (ŠKALJANJE)

- inner part of the wall is filled with stones of different sizes: first we put bigger ones, which are obviously harder to fit on face.
- then we proceed with smaller stones

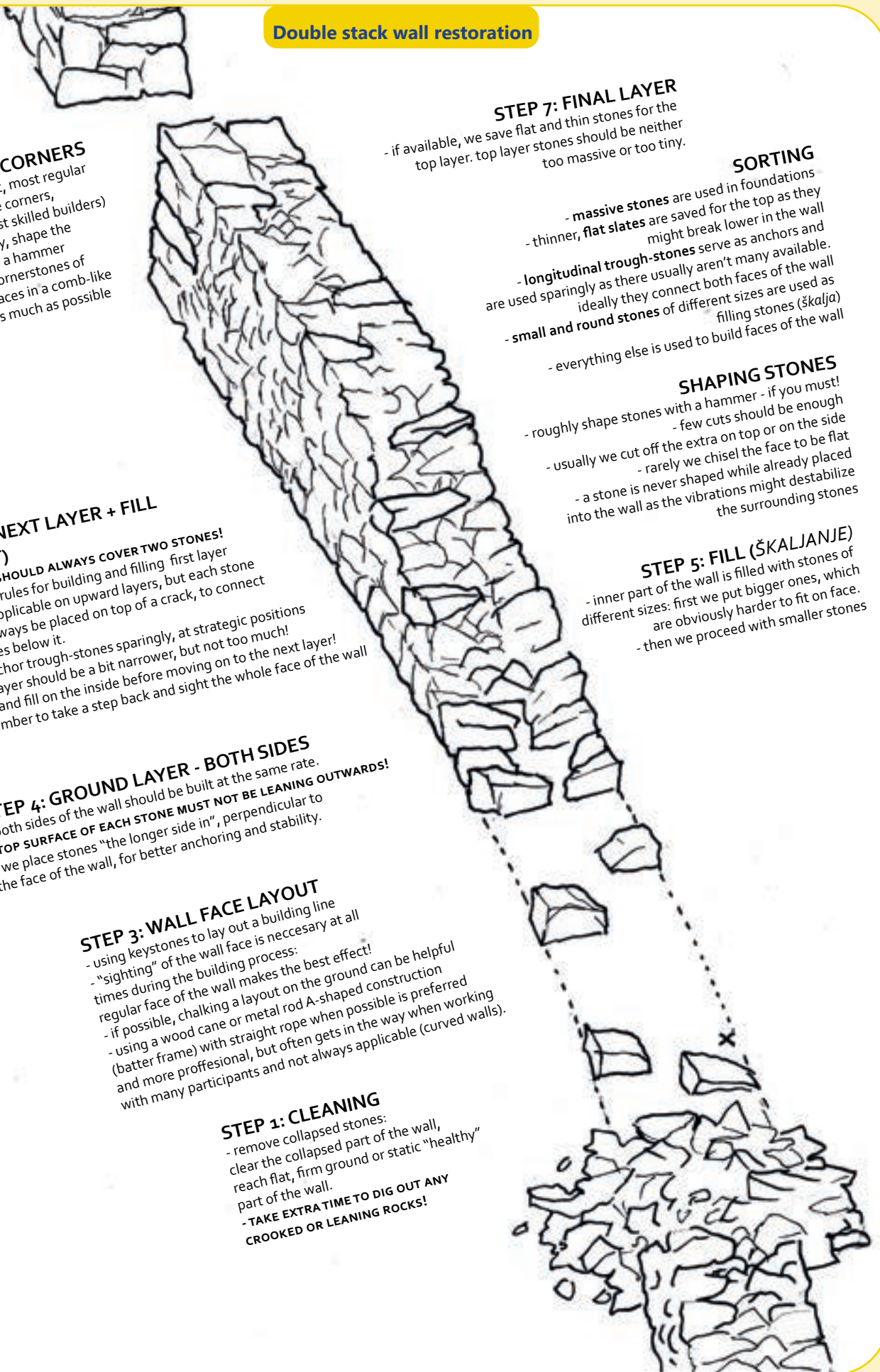

Retaining wall restoration

1) WALL IS TOO THIN, STONES LEAN OUTWARDS

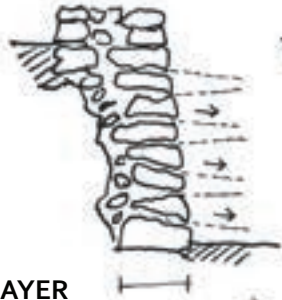

2) SOIL PRESSURE CAUSES WALL TO BULGE



3) WITH RAINFALL, THE WALL COLLAPSES



4) WALL IS REBUILT WITH EXTRA DEPTH, STONES LEAN INWARDS

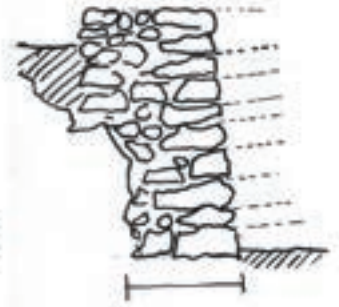

STEP 6: NEXT LAYER

+ FILL (REPEAT)

- A STONE SHOULD ALWAYS COVER TWO STONES!
- all of the rules for building and filling first layer are also applicable on upward layers, but each stone should always be placed on top of a crack, to connect the stones below it.
- use anchor stones sparingly, at strategic positions
- each layer should be a bit more indented, but not too much! we want to keep the vertical.
- remember to take a step back and sight the whole face of the wall at all times



6

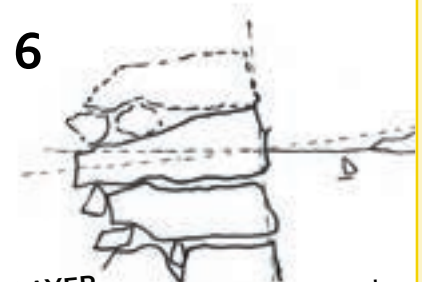

STEP 5: FILL (ŠKALJANJE)

- inner part of the wall is filled with stones of different sizes: first we put bigger ones, which are obviously harder to fit on face.
- then we proceed with smaller stones

STEP 4: GROUND LAYER

- TOP SURFACE OF EACH STONE MUST NOT BE LEANING OUTWARDS!
- we place stones "the longer side in", perpendicular to the face of the wall, for better anchoring and stability.
- if possible, especially with taller walls - build as if the wall is double stacked
- the inner stack can of course be more roughly built

STEP 3: WALL FACE LAYOUT

- "sighting" of the wall face is necessary at all times during the building process:
- regular face of the wall makes the best effect!
- adapt the reconstructed wall face to the existing terrace geometry

STEP 2: SORTING

- sorting of available stones:
- massive stones are used in foundations
- thinner, flat slates are saved for the top as they might break lower in the wall
- longitudinal stones serve as anchors and are used sparingly as there usually aren't many available. ideally they reach as far into the wall mass as possible
- small and round stones of different sizes are used as filling stones (škalja)
- everything else is used to build face of the wall

STEP 1: CLEANING

- remove collapsed stones:
- clear the collapsed part of the wall, reach flat, firm ground or static "healthy" part of the wall.
- TAKE EXTRA TIME TO DIG OUT ANY CROOKED OR OUTWARD-LEANING ROCKS!
- BE CAUTIOUS OF UNCONTROLLED COLLAPSE / LANDSLIDE ON STEEP TERRACES

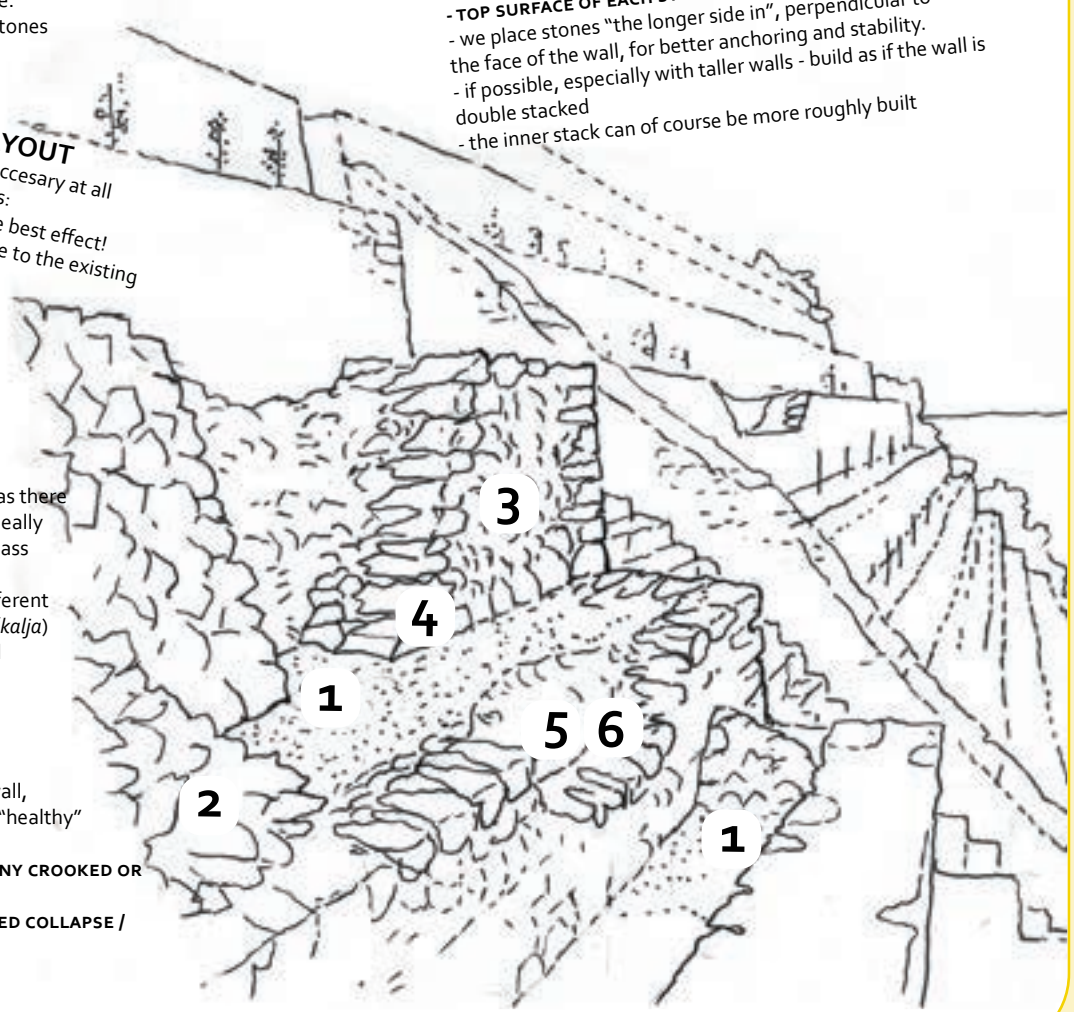

8

Restoring a stone slate roof





[See tutorial video on youtube](#)

1 Pedagogical Objectives

- **Technical Expertise:** Leaders should have in-depth knowledge and skills in stone slate roof restoration techniques.
- **Effective Communication:** They should communicate clearly and demonstrate techniques effectively.
- **Safety Leadership:** Prioritize safety, ensuring proper techniques and protocols are followed.
- **Team Coordination:** Coordinate tasks, foster teamwork, and resolve conflicts.
- **Problem-Solving:** Address challenges with critical thinking and adaptability.
- **Quality Assurance:** Ensure high-quality craftsmanship and attention to detail.
- **Educational Leadership:** Mentor participants, inspire learning, and encourage skill development.

These objectives aim to equip leaders with essential skills to guide and mentor participants effectively in stone slate roof restoration projects.

2 Technical Framework

-  **Duration:** Usually lasts for 7 days
-  **Participants:** a leader can handle 3 to 5 participants
-  **Level:** Beginner
-  **List of Materials:**
 - Stone slates of different sizes
 - Small hammer

3 Step by step instructions

1 Step 1: Wooden Construction

- **Tie Beams Installation**
Use 12x12 cm beams to establish the framework for the roof structure.
- **Roof Inclination**
Ensure the roof slope is moderate: not too steep to prevent slates from sliding and not too mild to facilitate rain runoff.

2 Step 2: Stone Slates Cover

- **Stone Slate Preparation**
Gather slates from collapsed roofs or excavate freshly from the ground. Allow them to undergo a year-long outdoor probation to endure weather and ensure suitability before use.
- **Layout of Stone Slates**
Start laying stone slates from the eaves and progress upwards to the ridge. Ensure proper overlapping to prevent water penetration: use onefold, twofold, or threefold overlapping methods as required.

3 Additional Steps

- **Ridge Beam Installation**
Use 10x10 cm beams for the ridge to support the topmost part of the roof structure.

- **Rafters Installation**
Install 10x12 cm rafters to support the slates and provide structural integrity.

- **Slats and Vegetation**
Use materials such as joprina, lemprika, and Viburnum tinus for additional layers or insulation between the slates.

By following these steps, participants can systematically restore a stone slate roof, ensuring durability and traditional construction methods are maintained.

4 Some common mistakes from beginner participants are:

- **Building with the "line of least resistance" to position each individual slate as "stable" as possible**, but without considering the entire roof.
- **Only installing the stone**, leaving the scaling to others, which places them in an incorrect position.
- **Only collecting the smaller stones**, staying away, and leaving the construction to others.
- **Building too quickly, evaluating little**, resulting in poor construction and inattention to their own body.
- **Not placing the stone** so that it can be built on.
- **Choosing only the most regular or largest slates.**
- **Slow constructing** due to excessive analysis, often questioning others and seeking approval for the embedded stone.

5 What leaders can do to help with the mistakes and insecurities

- **Continuously emphasize the basic rules** in practice and stress the importance of considering the entire roof and the desired outcome.
- **Encourage participants to step back periodically** to view the entire project from different angles.
- **Explain the workshop dynamics** and emphasize that beginners learn through following each step of construction, from installation to finishing. Highlight the importance of teamwork.
- **Demonstrate the installation of stones together** to encourage participation and learning.
- **Clarify that while small irregular slates can fill gaps in the roof**, they should not be directly placed on the roof but rather integrated into the interior.
- **Motivate participants to take ownership of their mistakes** and explain the long-term consequences of improper lifting techniques on the body.
- **Emphasize the domino effect of mistakes** and encourage careful planning to avoid cascading errors.
- **Acknowledge that due to stone weight, some participants may use smaller stones**; guide them to distribute these stones evenly across the roof to maintain balance.
- **Provide encouragement and motivation**, stressing the value of thoughtful construction with thoughtful questions over hurried decisions.

**PART A)
WOODEN CONSTRUCTION**

stone slates are laid out on to the wooden bearing construction. The wood, if gathered in the immediate natural surroundings, takes a lot of work and time to prepare through the year.

ROOF INCLINATION

- must not be too steep, slates might slide down
- must not be too mild, rain will run off too slowly
- slope is more mild on the eaves

**PART B)
STONE SLATES COVER**

- gathered from collapsed roof
- when freshly excavated from the ground, at least a year - long outdoors probation is necessary to endure weather and make selection before being built into the roof

LAYOUT

- stone slates are laid out bottom-to-top, starting from eaves going up to the ridge

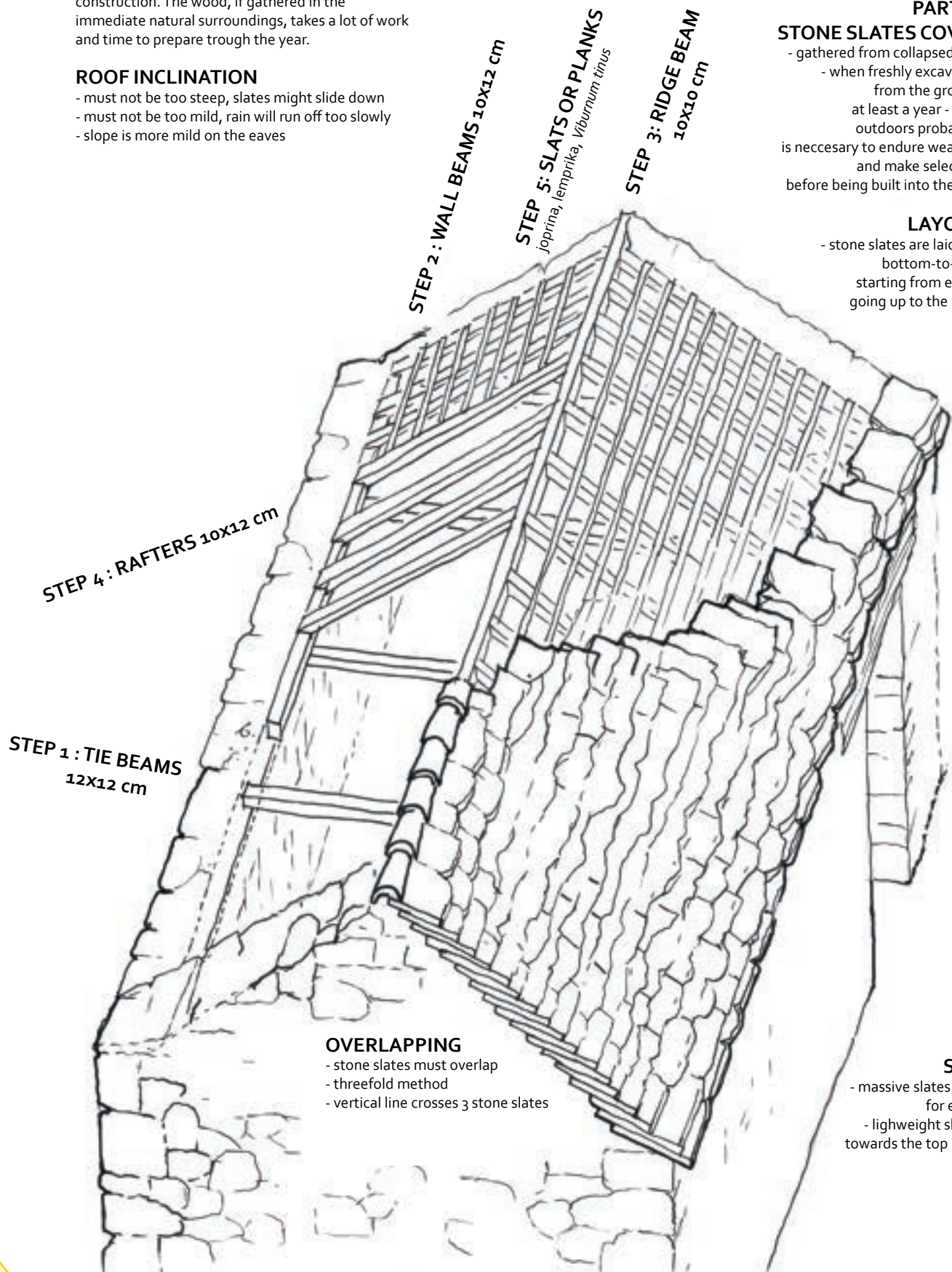

OVERLAPPING

- stone slates must overlap
- threefold method
- vertical line crosses 3 stone slates

SIZE

- massive slates used for eaves
- lightweight slates towards the top ridge

9

Heritage site restoration workshop camp

[See tutorial video on youtube](#) 

Workshop Organization

A workshop is an educational and public event aimed at teaching the art of dry stone wall construction during building renovations. Workshops can last from one day to several weeks, with preparation starting months in advance and intensifying weeks before the event. Coordinators, managers, organizers, and hosts are involved in the workshop's planning.

Key Differences from Professional Engagements

Workshops differ from professional renovations as they focus on transferring knowledge rather than commercial restoration goals. Participants learn dry stone construction over the workshop's duration, aiming to build sections of varying quality. For instance, a local association may organize workshops in collaboration with the municipality, educating participants in public spaces like roadsides.

General Notes

Leaders utilize available resources to achieve the workshop's goals based on agreed priorities. They experience the outcomes of effective preparation or manage consequences from inadequate preparation. Force majeure situations are addressed promptly in agreement with the organizer.

1

Organizer and Leader Responsibilities

- **Communication and Expectations:** Ensure clear communication with all stakeholders regarding workshop goals, participant expectations, and the educational nature of the event. Clarify differences from professional engagements and manage expectations regarding outcomes and participant learning.
- **Participant Management:** Confirm participant numbers and ensure effective communication of workshop details through various channels such as websites, direct agreements, posters, or community bulletin boards.
- **Stone Master Participation:** Coordinate with workshop leaders to arrange for skilled masters, ensuring their timely arrival and integration into the workshop activities.
- **Work Optimization:** Organize participants into manageable groups, with one leader assigned for every 3-5 beginners to ensure effective teaching and supervision. Larger groups may require additional leaders while maintaining an optimal learning environment.

- **Workshop Site Preparation:** Conduct site assessments well in advance, ideally with personal scouting by workshop coordinators or leaders. Ensure suitable public or educational locations unless exceptional circumstances require private land use.
- **Stone Evaluation and Ethics:** Assess available stone resources ethically, avoiding removal from existing structures or private properties. Collect fallen stones or procure additional materials responsibly, such as donations from quarries.
- **Site Cleanup and Security:** Prepare the construction site by clearing vegetation and ensuring a stable base. Prioritize safety with first aid kits onsite, basic first aid knowledge among leaders, and contingency plans for emergencies.
- **Participant Safety and Risk Awareness:** Communicate risks and safety measures to participants before the workshop, emphasizing personal responsibility through signed agreements. Provide assistance and transportation in case of accidents, with optional insurance coverage as needed.

2

Participant Supervision and Support**Knowledge Transfer Methods and Communication at the Workshop - Integrating Practical and Soft Skills of Leaders**

The leader monitors participant satisfaction, motivation, job performance, progress, and construction advancements. In addition to practical construction knowledge, leaders handle interpersonal skills relevant to both the worksite and leisure time. As the workshop duration increases, these skills become more critical due to increased interaction time with participants.

3 Key Responsibilities

- **Demonstration and Explanation:** The leader actively builds while verbally guiding participants through each construction phase. This practical-theoretical synergy is crucial for participant understanding of construction techniques.
- **Organization and Monitoring:** To facilitate monitoring and efficiency, participants are grouped into smaller teams (4-6 members per group). The leader ensures no group feels isolated, periodically gathering all participants to update them on progress and address specific situations.
- **Assessment of Work and Effectiveness:** The leader moves between groups, demonstrating and overseeing each construction phase, correcting participant errors promptly. Regular assessments throughout each phase help identify and rectify mistakes in a timely manner.
- **Identifying Further Educational Needs:** Continuous errors prompt additional education for individual participants or entire groups on problematic construction elements. Reiterating basic rules multiple times ensures understanding across various scenarios.
- **Prioritization Clarification:** The leader prioritizes skill acquisition over the quantity of constructed meters, emphasizing teamwork and engagement over isolation.
- **Safety Monitoring:** Ensuring volunteer safety throughout the workshop is a top priority for the leader.

4 Motivation and Communication

- **Enabling Flexibility:** Participants are encouraged to suggest and implement changes to their tasks, fostering a relaxed atmosphere where autonomy is valued.
- **Building Trust and Competence:** Trust is demonstrated by delegating tasks and allowing participants space to learn from their mistakes, rotating among groups to facilitate independent construction.
- **Progress Updates:** Providing regular feedback on task progress and actively listening to participant input helps maintain motivation.
- **Sustaining Motivation:** Effective mentoring and supervision play a crucial role in sustaining and boosting motivation. Celebrating achievements and emphasizing personal responsibility inspire participants to take pride in their work and contributions.

This approach ensures effective knowledge transfer and supports participants' growth and confidence throughout the workshop.

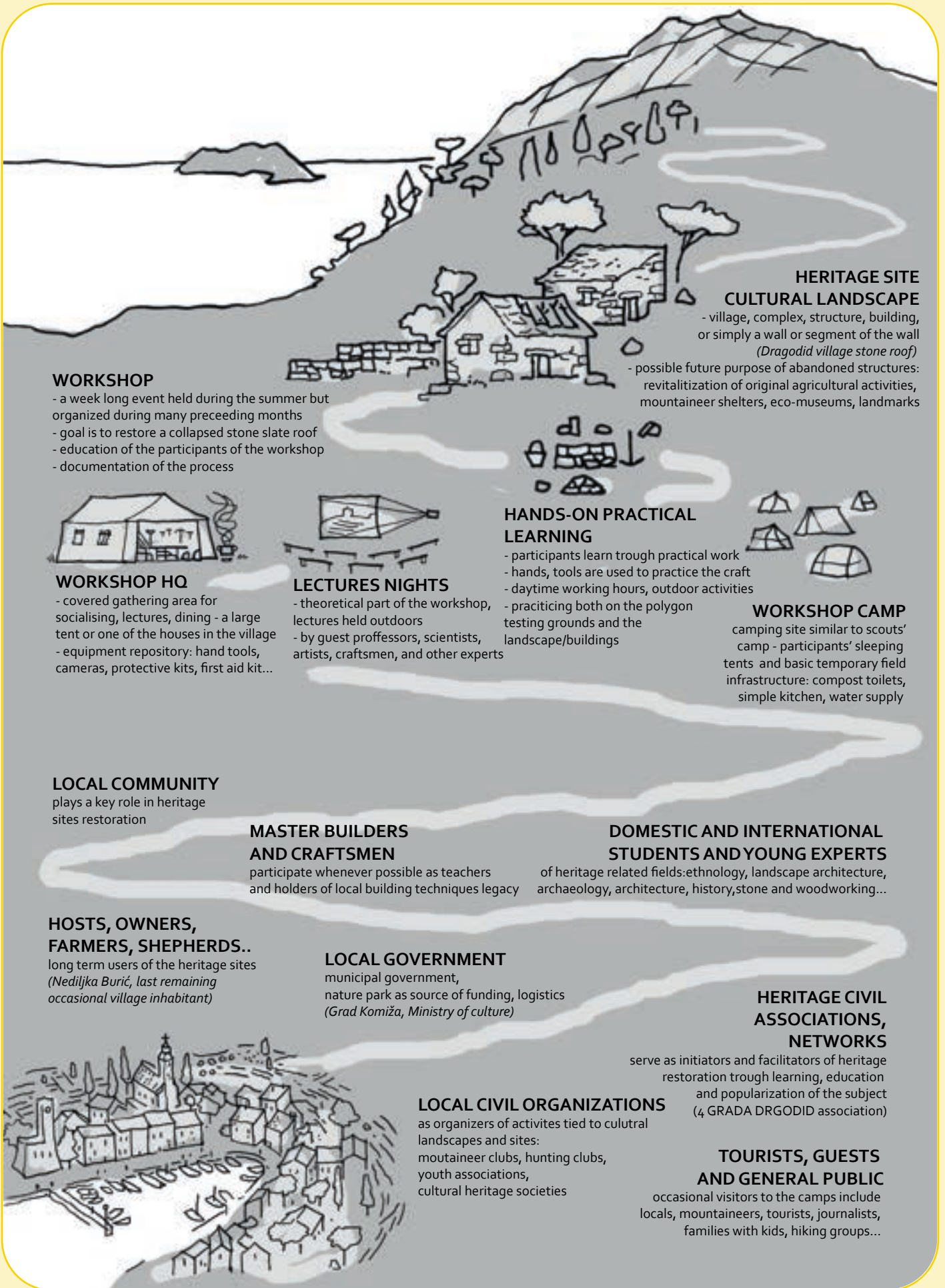

HERITAGE SITE CULTURAL LANDSCAPE

- village, complex, structure, building, or simply a wall or segment of the wall (*Dragodid village stone roof*)
- possible future purpose of abandoned structures: revitalization of original agricultural activities, mountaineer shelters, eco-museums, landmarks

WORKSHOP

- a week long event held during the summer but organized during many preceding months
- goal is to restore a collapsed stone slate roof
- education of the participants of the workshop
- documentation of the process



WORKSHOP HQ

- covered gathering area for socialising, lectures, dining - a large tent or one of the houses in the village
- equipment repository: hand tools, cameras, protective kits, first aid kit...



LECTURES NIGHTS

- theoretical part of the workshop, lectures held outdoors
- by guest professors, scientists, artists, craftsmen, and other experts

HANDS-ON PRACTICAL LEARNING

- participants learn through practical work
- hands, tools are used to practice the craft
- daytime working hours, outdoor activities
- practicing both on the polygon testing grounds and the landscape/buildings



WORKSHOP CAMP

- camping site similar to scouts' camp - participants' sleeping tents and basic temporary field infrastructure: compost toilets, simple kitchen, water supply

LOCAL COMMUNITY

plays a key role in heritage sites restoration

MASTER BUILDERS AND CRAFTSMEN

participate whenever possible as teachers and holders of local building techniques legacy

DOMESTIC AND INTERNATIONAL STUDENTS AND YOUNG EXPERTS

of heritage related fields: ethnology, landscape architecture, archaeology, architecture, history, stone and woodworking...

HOSTS, OWNERS, FARMERS, SHEPHERDS..

long term users of the heritage sites (*Nediljka Burić, last remaining occasional village inhabitant*)

LOCAL GOVERNMENT

municipal government, nature park as source of funding, logistics (*Grad Komiža, Ministry of culture*)

HERITAGE CIVIL ASSOCIATIONS, NETWORKS

serve as initiators and facilitators of heritage restoration through learning, education and popularization of the subject (4 GRADA DRGODID association)

LOCAL CIVIL ORGANIZATIONS

as organizers of activities tied to cultural landscapes and sites: mountaineer clubs, hunting clubs, youth associations, cultural heritage societies

TOURISTS, GUESTS AND GENERAL PUBLIC

occasional visitors to the camps include locals, mountaineers, tourists, journalists, families with kids, hiking groups...



10 Workshop organization

[See tutorial video on youtube](#) 



Project planning



Good practices

Concept note and proposal	For preliminary communication with partners and funders.
Budget	Include contingencies min 10%
Funding	Try multiple sources with smaller amounts and in-kind sponsorship
Partners/Coorganisers	Ask for cofinancing of expenses



Educational program

Theory (presentations, seminars)	Balance both around 50%
Hands-on	Include actual construction project
Excursions/visits	Guided walks are highly recommended.
Community activities	Engage with local community with open worksite days, open presentations and feasts
Public dialogue/ Conference day(s)	Raise awareness on important topics related to the program
Other parallel activities	Explore local culture through minor activities with locals



Communication plan

Communication material (Posters, leaflets, banners)	Ideally collaborate with a graphic designer
Open call	Publish online and send to all relevant institutes and media
Public program	Make a poster for the open events
Dissemination (Website, Social media, etc)	Make a plan for the Social media posts



Construction program

Studies - Permits	Get them as early as possible!
Building materials	Try to reuse old material and locally sourced/manufactured natural materials
Tools, equipment and consumables	Necessary PPE for all participants, enough tools according to the arrangement of works and safety pharmacy.
Insurance	Arrange a civil liability insurance
Worksite preparation	Shade for sun protection might be required



Human resources

Project team
Tutors - craftspeople
Lecturers/guest speakers
Video maker
Interpreter



Good practices

Open positions for volunteers who will help with simple tasks
Find local craftspeople who possess local knowledge
Invite also local experts
Important for dissemination and documentation
Somebody from the team could undertake this task or presentations could be held in english if everybody understands



Participants management

Preparatory guidelines
Accommodation
Food
Transport
Kit (e.g. Tote bag, notebook, t-shirt)
Insurance

How to reach, what to bring, what to expect, local information for ATMs, pharmacies and cultural sites/events
Arrange shared rooms for participants which helps them save money
Arrange cooking on site if possible or let them eat in the local taverns to support local economy
Share contact information between participants in case they want to share a ride
Notebooks are really useful!
All participants should have health insurance in case of any accident



Implementation

Organise on-site tasks
Introductions and presentation of program
Theory and seminars
Hands-on practice
Community and open activities
Complete/close financial and other arrangements

For detailed description on these sections study Section 1, pgs 12-29 of this handbook.



Post production

Evaluation
Share educational material
Dissemination though Social media and Website

Share online forms right after the workshop
Ask the speakers to share their presentations
Better to post during the events

Bibliography



[*Video on material reuse*](#)

[*An EU- based website to facilitate the reuse of materials in construction and renovation projects*](#)

EU relevant documents and policies for inclusion and sustainability within the context of heritage

[*New European Bauhaus*](#)

[*Putting Europe's shared heritage at the heart of the European Green Deal*](#)

[*European Competence Framework*](#)

[*Climate Heritage Network*](#)

[*REMPART white paper on ecological aspects and heritage*](#)

General

[*UNESCO World Heritage Sites | Art of dry stone walling, knowledge and techniques*](#)

[*Convegno SNAPS 2022 - The Art of Dry Stone Walling - Before&After, Greece, Ioulia K Papaeftychiou*](#)

[*Convegno SNAPS 2022 - The Art of Dry Stone walling - Past, future - 'Ada Acovitsioti-Hameau \(SPS\)*](#)

[*Safety*](#)

European projects

[*Charter alliance*](#)

[*Heritage pro*](#)

[*Culture labs*](#)

[*B10N*](#)



Trainees preparing mortar
©JC. Verchère



HERO

HERITAGE ECOLOGICAL RESTORATION
FOR INCLUSION OPPORTUNITIES



Co-funded by
the European Union

This toolkit is the result of the Erasmus+ project "HERO - Heritage Ecological Restoration for inclusion Opportunities", result of a cooperation between Acta Vista (France), BAO Formation (France), Pour la Solidarité (Belgium), Dragodid (Croatia) and Boulouki (Greece).

Co-funded by the European Union. Views and opinions expressed are however those of the author(s) only and do not necessarily reflect those of the European Union or the European Education and Culture Executive Agency (EACEA). Neither the European Union nor EACEA can be held responsible for them.

